

Frame / Module

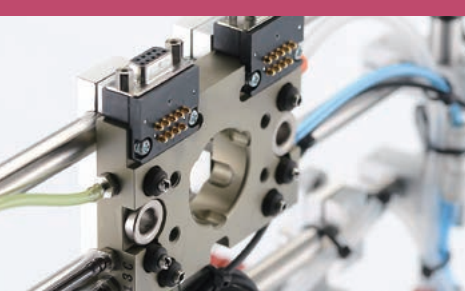

Jungle Gym 5-2

- ▶ List of Jungle Gym 5-3
- ▶ Jungle Gym SS Pipe / Fixture Made of Resin 5-8
- ▶ Pipe End Cap / SS Pipe Cutter / Clip 5-9
- ▶ Jungle Gym Series Parts (Connector) 5-10
- ▶ Jungle Gym Series Parts (Bracket) 5-13
- ▶ Jungle Gym Series Parts (Rotate) 5-19
- ▶ Jungle Gym Series Parts (Slide) 5-21
- ▶ Jungle Gym Series Parts (Washer) 5-24
- ▶ Jungle Gym Series Parts (Nut / Bushing) 5-25
- ▶ Base Frame Module 5-26
- ▶ Suction Module 5-30
- ▶ Gripper Module 5-31
- ▶ Limit Switch Module 5-34

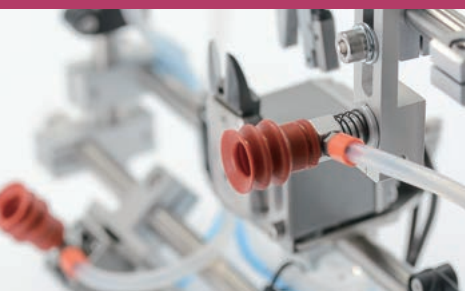

Let's Joint 5-36

- ▶ List of Let's Joint 5-37
- ▶ Base Frame Module 5-40
- ▶ Suction Module 5-42
- ▶ Gripper Module 5-43
- ▶ Limit Switch Module 5-46



Rectangular Tube 5-48

- ▶ Rectangular Tube / Tube End Cap 5-49
- ▶ Rectangular Tube Series Parts 5-50



Base Aluminum Material 5-52



Sliding Chuck 5-54

Quick Chuck Change

Quick Chuck Change (Manual)

Tool Changer

Automated Chuck Exchange System

Grip

Mini Cylinder

Accessories for Mini Cylinder

Container Cylinders

Accessories for Container Cylinder

Grippers

Buffer Material

Suction

Suction Cups

Suction Stem

Pad in Pad

Air Ejector / Filter / Check Valve

Micro Mold E.O.A.T

Cut

Mini Air Nippers

Air Nippers

Frame/Module

Jungle Gym

Let's Joint

Rectangular Tube

Base Aluminum Material

Sliding Chuck

Tubing/Sensors

Tubing

Sensors

Other Products

Others

Information

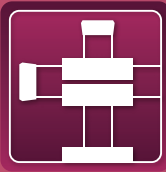

Jungle Gym

- ▶ Features enough rigidity and weight reduction. Frame is made of thin-wall stainless. And connection connector is made of super duralumin.
- ▶ Time for adjustment is reduced by easy position adjustment of chuck parts and easy positioning.

Frame / Module

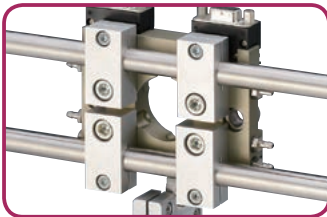

Grip

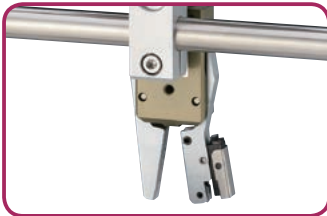

Cut

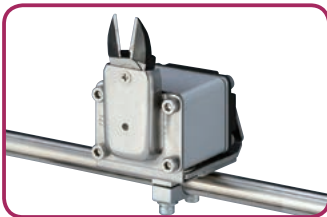

Suction

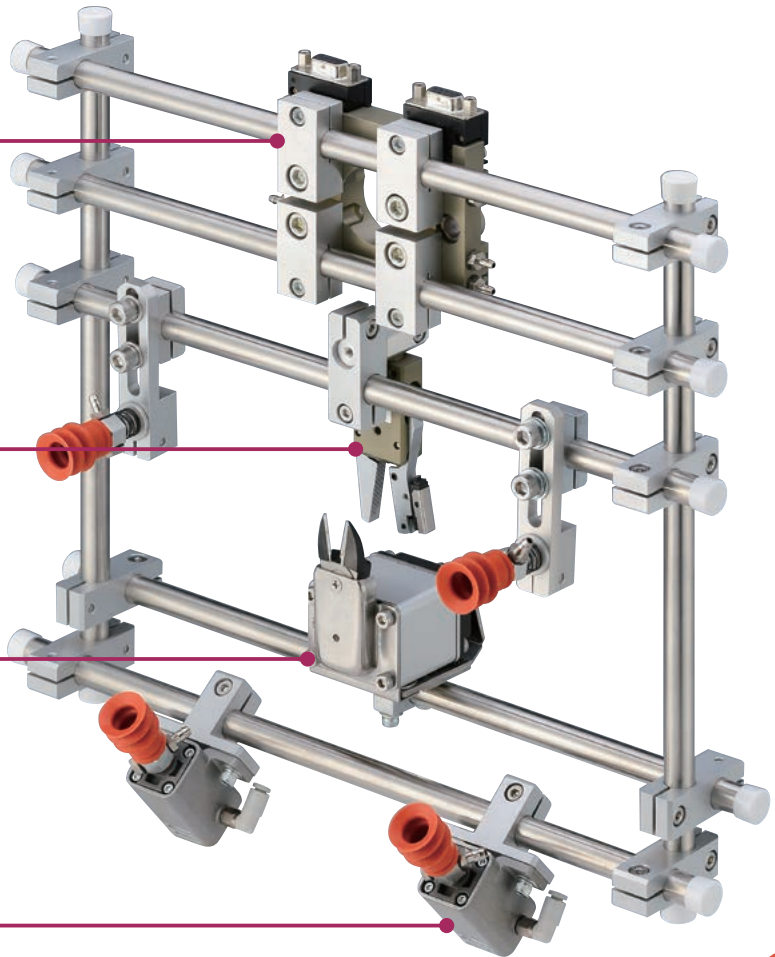
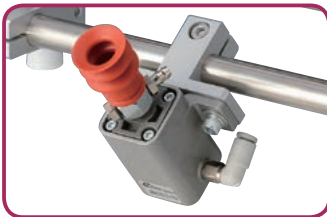

Tubing **6-1**

Three kinds of SS pipes ($\phi 8 / \phi 12 / \phi 20$) are basic components of jungle gym series to create chuck plate. Determine extract method first. And choose your favorite parts from the product list. The assemble them. Use jungle gym modules in [5-26](#) to create your chuck plate easily.

Example of using other components

- ▶ Suction cup + Suction stem + Rotation bracket + Cross connector

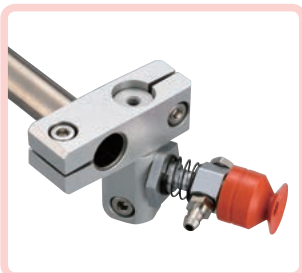

| | |
|----------------|-----------------|
| Order code No. | 210193 |
| Standard | VAPH-15C |



| | |
|----------------|-------------------|
| Order code No. | 131173 |
| Standard | N01864-306 |



| | |
|----------------|------------------|
| Order code No. | 210974 |
| Standard | VFIL-S-5A |



| | |
|----------------|-------------------|
| Order code No. | 131099 |
| Standard | N01861-202 |

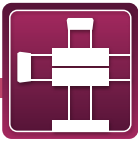

List of Jungle Gym

Various parts can be attached to jungle gym SS $\phi 8$, $\phi 12$, and $\phi 20$.

Jungle gym



You can see moving images of products by using QR code reader of your smartphone.

Specification

| | Product name | Image | Order code No. | Page of |
|-----------------------|------------------------------------|-------|---------------------------------|---------|
| | | | Standard | details |
| Frame | Jungle gym • SS pipe $\phi 8$ | | 340905 8*0.6*500 | 5-8 |
| | | | 340906 8*0.6*1000 | |
| | | | 340907 8*0.6*1500 | |
| | | | | |
| | Jungle gym • SS pipe $\phi 12$ | | 271527 12*0.6*500 | |
| | | | 271528 12*0.6*1000 | |
| | | | 271529 12*0.6*1500 | |
| | | | | |
| | Jungle gym • SS pipe $\phi 20$ | | 281812 20*0.8*500 | |
| | | | 281813 20*0.8*1000 | |
| | | | 281814 20*0.8*1500 | |
| | | | | |
| Fixture made of resin | Tie wrap base $\phi 12$ (tie band) | | 171210 RCA12 | |
| | Tie wrap base $\phi 20$ (tie band) | | 171211 RCA20 | |
| | Tie wrap base $\phi 12$ (M4) | | 171212 RCB12 | |
| | Tie wrap base $\phi 20$ (M4) | | 171213 RCB20 | |
| Pipe end cap | Pipe end cap $\phi 8$ | | 131212 N01902-003 | |
| | Pipe end cap $\phi 12$ | | 131211 N01902-002 | |
| | Pipe end cap $\phi 20$ | | 131210 N01902-001 | |
| SS pipe cutter | SS pipe cutter | | 101206 K-203 | |
| | SS pipe cutter blade | | 101207 K-203-1 | |
| Clip | Clip • TMA • $\phi 20 * \phi 20$ | | 196559 TMA-CL (20*20) | |
| | Clip • TMA • $\phi 20 * \phi 12$ | | 196560 TMA-CL (20*12) | |

| | Product name | Image | Order code No. | Page of |
|-----------|-----------------------------------------------------|-------|---------------------------------|---------|
| | | | Standard | details |
| Clip | Clip • TMA • $\phi 12 * \phi 12$ | | 196561 TMA-CL (12*12) | 5-9 |
| | Clip • TMA • $\phi 12 * \phi 8$ | | 196562 TMA-CL (12*8) | |
| | Clip • TMA • $\phi 8 * \phi 8$ | | 196563 TMA-CL (8*8) | |
| | Clip • TMA • $\phi 12 * \phi 10$ | | 196564 TMA-CL (12*10) | |
| Connector | Cross connector • $\phi 8 \phi 8$ | | 131102 N01861-207 | 5-10 |
| | Cross connector • $\phi 12 \phi 8$ | | 131098 N01861-201 | |
| | Cross connector • $\phi 12 \phi 12$ | | 131099 N01861-202 | |
| | Cross connector • $\phi 20 \phi 12$ | | 131100 N01861-204 | |
| | Cross connector • $\phi 20 \phi 20$ | | 131101 N01861-206 | |
| | Cross connector • long • $\phi 20 \phi 20$ | | 131573 N01861-206B | |
| | Cross connector • $\phi 12 \phi 12$ (rear entrance) | | 131569 N01861-202A | |
| | Cross connector • $\phi 20 \phi 20$ (rear entrance) | | 131570 N01861-206A | |
| | Connector • for SSW | | 131097 N01861-108 | |
| | T Connector # 1 • $\phi 8 \phi 8$ | | 131108 N01861-306 | |
| | T Connector # 1 • $\phi 8 \phi 12$ | | 131105 N01861-303 | |
| | T Connector # 1 • $\phi 12 \phi 8$ | | 131104 N01861-302 | |
| | T Connector # 1 • $\phi 12 \phi 12$ | | 131103 N01861-301 | |
| | T Connector # 1 • $\phi 12 \phi 20$ | | 131109 N01861-307 | |
| | T Connector # 1 • $\phi 20 \phi 12$ | | 131106 N01861-304 | |
| | T Connector # 1 • $\phi 20 \phi 20$ | | 131107 N01861-305 | |

Quick Chuck Change

Quick Chuck Change (Manual)

Tool Changer

Automated Chuck Exchange System

Grip

Mini Cylinder

Accessories for Mini Cylinder

Container Cylinders

Accessories for Container Cylinder

Grippers

Buffer Material

Suction

Suction Cups

Suction Stem

Pad in Pad

Air Ejector/Filter/Check Valve

Micro Mold E.O.A.T

Cut

Mini Air Nippers

Air Nippers

Frame/Module

Jungle Gym

Let's Joint

Rectangular Tube

Base Aluminum Material

Sliding Chuck

Tubing/Sensors

Tubing















Sensors



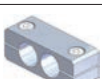
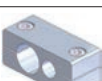

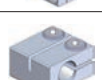

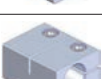









Other Products

















Others

















Information

List of Jungle Gym

| Product name | Order code No. Standard | Page of details | | |
|--------------|---------------------------------------------|-------------------------------------------------------------------------------------|-----------------------------|------|
| | | | | |
| Connector | T Connector #2 • ϕ 8 ϕ 8 |  | 131115 N01861-406 | 5-11 |
| | T Connector #2 • ϕ 8 ϕ 12 |  | 131112 N01861-403 | |
| | T Connector #2 • ϕ 12 ϕ 8 |  | 131111 N01861-402 | |
| | T Connector #2 • ϕ 12 ϕ 12 |  | 131110 N01861-401 | |
| | T Connector #2 • ϕ 12 ϕ 20 |  | 131116 N01861-407 | |
| | T Connector #2 • ϕ 20 ϕ 12 |  | 131113 N01861-404 | |
| | T Connector #2 • ϕ 20 ϕ 20 |  | 131114 N01861-405 | 5-12 |
| | Parallel connector • ϕ 8 ϕ 8 |  | 131096 N01861-107 | |
| | Parallel connector • ϕ 8 ϕ 12 |  | 131092 N01861-101 | |
| | Parallel connector • ϕ 12 ϕ 12 |  | 131093 N01861-102 | |
| | Parallel connector • ϕ 20 ϕ 12 |  | 131094 N01861-104 | |
| | Parallel connector • ϕ 20 ϕ 20 |  | 131095 N01861-106 | |
| | Cross connector #2 • ϕ 20 ϕ 20 |  | 131117 N01861-501 | 5-13 |
| | Straight connector • ϕ 8 |  | 131488 N01868-501 | |
| | Straight connector • ϕ 12 |  | 131489 N01868-502 | |
| | Straight connector • ϕ 20 |  | 131490 N01868-503 | |
| Bracket | Access bracket • ϕ 12 • M6 |  | 131125 N01862-210 | |

| Product name | Order code No. Standard | Page of details | | |
|---------------|---------------------------------------------------------------------------------------|---------------------------------------------------------------------------------------|-----------------------------|------|
| | | | | |
| Bracket | Access bracket • ϕ 20 • M6 |  | 131126 N01862-211 | 5-13 |
| | Attachment bracket • ϕ 8 • M5 |  | 131306 N01862-208 | |
| | Attachment bracket • ϕ 8 • M6 |  | 131121 N01862-205 | |
| | Attachment bracket • ϕ 12 • M5 |  | 131305 N01862-204 | |
| | Attachment bracket • ϕ 12 • M6 |  | 131118 N01862-201 | |
| | Attachment bracket • ϕ 12 • M8 |  | 131225 N01862-213 | |
| | Attachment bracket • ϕ 20 • M6 |  | 131123 N01862-207 | 5-14 |
| | Attachment bracket • ϕ 20 • M8 |  | 131226 N01862-214 | |
| | Suction bracket • ϕ 8 • M5 |  | 131122 N01862-206 | |
| | Suction bracket • ϕ 8 • M6 |  | 131124 N01862-209 | |
| | Suction bracket • ϕ 12 • M5 |  | 131119 N01862-202 | |
| | Suction bracket • ϕ 12 • M6 |  | 131127 N01862-212 | |
| | Suction bracket • ϕ 12 • PT1/8 |  | 131120 N01862-203 | |
| | Cylinder bracket • ϕ 8 |  | 131075 N01915-113 | 5-14 |
| | Cylinder bracket • ϕ 12 |  | 131074 N01915-112 | |
| | Cylinder bracket • ϕ 20 |  | 131066 N01915-103 | |
| Swing bracket |  | 131065 N01915-102 | | |

| Product name | Order code No. Standard | Page of details | | | |
|--------------|---------------------------------|-------------------------------------------------------------------------------------|-----------------------------|------|------|
| | | | | | |
| Bracket | Slide bracket • φ 8 |  | 131151 N01863-207 | 5-15 | |
| | Slide bracket • φ 12 |  | 131145 N01863-201 | | |
| | Slide bracket • φ 20 |  | 131149 N01863-205 | | |
| | Slide bracket • W • φ 8 |  | 131217 N01863-113 | | |
| | Slide bracket • W • φ 12 |  | 131128 N01863-101 | | |
| | Slide bracket • W • φ 20 |  | 131134 N01863-111 | | |
| | Sensor bracket • φ 12 |  | 131189 N01867-101 | 5-16 | |
| | Sensor bracket |  | 131077 N01915-201 | | |
| | Chuck bracket • TH • φ 8 |  | 131188 N01866-502 | | |
| | Chuck bracket • TH • φ 12 |  | 131187 N01866-501 | | |
| | Chuck bracket • φ 12 |  | 131067 N01915-105 | | |
| | Nipper bracket • A |  | 131078 N01915-301 | | |
| | Nipper bracket • B |  | 131216 N01915-302 | | |
| | Nipper bracket • C |  | 131080 N01915-303 | | |
| | Nipper bracket • D |  | 131081 N01915-304 | | |
| | Nipper bracket • E |  | 131082 N01915-305 | | 5-17 |
| | Bracket • L • φ 8 • for UMCD |  | 131180 N01866-202 | | |

| Product name | Order code No. Standard | Page of details | | | | |
|--------------|----------------------------------|---------------------------------------------------------------------------------------|---------------------------------------------------------------------------------------|-----------------------------|------|------|
| | | | | | | |
| Bracket | Bracket • L • φ 12 • for MCD |  | 131179 N01866-201 | 5-17 | | |
| | Bracket • T • φ 12 • for MCD |  | 131176 N01866-101 | | | |
| | Bracket • T • φ 20 • for MCD |  | 131554 N01866-103A | | | |
| | Bracket • T • φ 8 • for UMCD |  | 131177 N01866-102 | | | |
| | Bracket • TH • φ 8 • for UMCD |  | 131182 N01866-302 | | | |
| | Bracket • TH • φ 12 • for MCD |  | 131181 N01866-301 | | | |
| | Bracket • TH • φ 20 • for MCD |  | 131183 N01866-303 | | | |
| | Bracket • TV • φ 8 • for UMCD |  | 131185 N01866-402 | | | |
| | Bracket • TV • φ 12 • for MCD |  | 131184 N01866-401 | | | |
| | Bracket • TV • φ 20 • for MCD |  | 131186 N01866-403 | | | |
| | Bracket | Bracket • φ 8 |  | 131073 N01915-111 | 5-18 | |
| | | Bracket • φ 12 |  | 131071 N01915-109 | | |
| | | Bracket • φ 20 |  | 131072 N01915-110 | | |
| | | Bracket • W • φ 8 |  | 131070 N01915-108 | | |
| | | Bracket • W • φ 12 |  | 131068 N01915-106 | | |
| | | Bracket • W • φ 20 |  | 131069 N01915-107 | | 5-19 |
| | | Bracket • NCON |  | 131083 N01915-401 | | |

Quick Chuck Change

Quick Chuck Change (Manual)

Tool Changer

Automated Chuck Exchange System

Grip

Mini Cylinder

Accessories for Mini Cylinder

Container Cylinders

Accessories for Container Cylinder

Grippers

Buffer Material

Suction

Suction Cups

Suction Stem

Pad in Pad

Air Ejector/Filter/Check Valve

Micro Mold E.O.A.T

Cut

Mini Air Nippers

Air Nippers

Frame/Module

Jungle Gym

Let's Joint

Rectangular Tube

Base Aluminum Material

Sliding Chuck

Tubing/Sensors

Tubing















Sensors



















Other Products

Others















Information

List of Jungle Gym

| Product name | Image | Order code No. | Page of details |
|---------------------------------------|-------------------------------------------------------------------------------------|----------------|-----------------|
| | | Standard | |
| Rotation bracket • ϕ 20 |  | 131064 | 5-19 |
| | | N01915-101 | |
| Rotation bracket • M10 • 8A |  | 131172 | |
| | | N01864-305 | |
| Rotation bracket • M12 • 12A |  | 131173 | |
| | | N01864-306 | |
| Rotation bracket • M17 • 20A |  | 131174 | |
| | | N01864-307 | |
| Rotation bracket • PT1/8 • 8A |  | 131175 | |
| | | N01864-401 | |
| Rotation bracket • ϕ 8 • 8A |  | 131170 | |
| | | N01864-303 | |
| Rotation bracket • ϕ 8 • 8B |  | 131606 | |
| | | N01864-103A | |
| Rotation bracket • ϕ 8 • M5A |  | 131164 | |
| | | N01864-202 | |
| Rotation bracket • ϕ 8 • M10A |  | 131435 | |
| | | N01864-201 | |
| Rotation bracket • ϕ 8 • M12A |  | 131433 | |
| | | N01864-205 | |
| Rotation bracket • ϕ 12 • PT1/8A |  | 131166 | |
| | | N01864-204 | |
| Rotation bracket • ϕ 12 • 8A |  | 131169 | |
| | | N01864-302 | |
| Rotation bracket • ϕ 12 • 8B |  | 131600 | |
| | | N01864-101A | |
| Rotation bracket • ϕ 12 • 12A |  | 131168 | |
| | | N01864-301 | |
| Rotation bracket • ϕ 12 • 12AL |  | 131567 | |
| | | N01864-301L | |
| Rotation bracket • ϕ 12 • 12B |  | 131605 | |
| | | N01864-102A | |
| Rotation bracket • ϕ 20 • 20A |  | 131171 | |
| | | N01864-304 | |
| Rotation bracket • ϕ 20 • 20AL |  | 131568 | |
| | | N01864-304L | |

| Product name | Image | Order code No. | Page of details |
|-------------------------------------|---------------------------------------------------------------------------------------|----------------|-----------------|
| | | Standard | |
| Suction rotate # A • ϕ 8 |  | 131194 | 5-21 |
| | | N01868-104 | |
| Suction rotate # A • ϕ 12 |  | 131191 | |
| | | N01868-101 | |
| Suction rotate # B • M3 • ϕ 8 |  | 131195 | |
| | | N01868-105 | |
| Suction rotate # B • M5 • ϕ 12 |  | 131192 | |
| | | N01868-102 | |
| Slide bracket 40 • M3 |  | 131158 | |
| | | N01863-214 | |
| Slide bracket 40 • M5 |  | 131147 | |
| | | N01863-203 | |
| Slide bracket 40 • M6 |  | 131156 | |
| | | N01863-212 | |
| Slide bracket 40 • PT1/8 |  | 131154 | |
| | | N01863-210 | |
| Slide bracket 40 • W • M10 |  | 131139 | |
| | | N01863-117 | |
| Slide bracket 40 • W • M12 |  | 131140 | |
| | | N01863-118 | |
| Slide bracket 40 • W • M17 |  | 131143 | |
| | | N01863-122 | |
| Slide bracket 40 • ϕ 8 |  | 131152 | |
| | | N01863-208 | |
| Slide bracket 40 • W • ϕ 8 |  | 131131 | |
| | | N01863-106 | |
| Slide bracket 40 • W • ϕ 12 |  | 131132 | |
| | | N01863-107 | |
| Slide bracket 40 • W • ϕ 20 |  | 131137 | |
| | | N01863-114 | |
| Slide bracket 40 • T • W • ϕ 8 |  | 230051 | |
| | | XL0005-102 | |
| Slide bracket 40 • T • ϕ 8 |  | 230056 | |
| | | XL0005-107 | |
| Slide bracket 40 • T • ϕ 12 |  | 230052 | |
| | | XL0005-103 | |

| Product name | Order code No. Standard | Page of details | | |
|--------------|----------------------------------------|-------------------------------------------------------------------------------------------------------------|------|------|
| | | | | |
| Bracket | Slide bracket 40 • T • ϕ 20 |  230054 XL0005-105 | 5-23 | |
| | Slide bracket 70 • M3 |  131159 N01863-217 | | |
| | Slide bracket 70 • M5 |  131148 N01863-204 | | |
| | Slide bracket 70 • M6 |  131157 N01863-213 | | |
| | Slide bracket 70 • PT1/8 |  131155 N01863-211 | | |
| | Slide bracket 70 • W • M10 |  131141 N01863-120 | | |
| | Slide bracket 70 • W • M12 |  131142 N01863-121 | | |
| | Slide bracket 70 • W • M17 |  131144 N01863-124 | | |
| | Slide bracket 70 • ϕ 8 |  131153 N01863-209 | | |
| | Slide bracket 70 • W • ϕ 8 |  131133 N01863-110 | | |
| | Slide bracket 70 • W • ϕ 12 |  131130 N01863-103 | | |
| | Slide bracket 70 • W • ϕ 20 |  131138 N01863-115 | | |
| | Slide bracket 70 • T • W • ϕ 8 |  230053 XL0005-104 | | 5-24 |
| | Slide bracket 70 • T • ϕ 8 |  230057 XL0005-108 | | |
| | Slide bracket 70 • T • ϕ 12 |  230050 XL0005-101 | | |
| | Slide bracket 70 • T • ϕ 20 |  230055 XL0005-106 | | |

| Product name | Order code No. Standard | Page of details | |
|------------------------------------|--------------------------------------------|---------------------------------------------------------------------------------------------------------------|---------------------------------------------------------------------------------------------------------------|
| | | | |
| Washer | Slide washer • ϕ 8 / ϕ 12 |  131146 N01863-202 | 5-24 |
| | Slide washer • W • ϕ 8 / ϕ 12 |  131129 N01863-102 | |
| | Slide washer • ϕ 20 |  131150 N01863-206 | |
| | Slide washer • W • ϕ 20 |  131135 N01863-112 | |
| Nut plates | Nut plate • for slide bracket |  023197 CP-076 | 5-25 |
| | Nut | Bushing nut • ϕ 8 • M5 | |
| Bushing nut • ϕ 8 • M6 | |  131206 N01868-410 | |
| Bushing nut • ϕ 12 • M5 | |  131202 N01868-403 | |
| Bushing nut • ϕ 12 • M10 | |  131201 N01868-402 | |
| Bushing nut • ϕ 12 • PT1/8 | |  131207 N01868-411 | |
| Bushing nut • ϕ 20 • M12 | |  131205 N01868-409 | |
| Bushing nut • ϕ 20 • PT1/8 | |  131199 N01868-305 | |
| Bushing nut • M5-M3 | |  131204 N01868-407 | |
| Bushing | | Bushing • ϕ 12 ϕ 8 |  131196 N01868-301 |
| | | Bushing • ϕ 20 ϕ 8 |  131197 N01868-302 |
| | | Bushing • ϕ 20 ϕ 12 |  131198 N01868-303 |

Quick Chuck Change

Quick Chuck Change (Manual)

Tool Changer

Automated Chuck Exchange System

Grip

Mini Cylinder

Accessories for Mini Cylinder

Container Cylinders

Accessories for Container Cylinder

Grippers

Buffer Material

Suction

Suction Cups

Suction Stem

Pad in Pad

Air Ejector/Filter/Check Valve

Micro Mold E.O.A.T

Cut

Mini Air Nippers

Air Nippers

Frame/Module

Jungle Gym

Let's Joint

Rectangular Tube

Base Aluminum Material

Sliding Chuck

Tubing/Sensors

Tubing

Sensors

Other Products

Others

Information

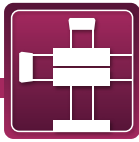

Jungle Gym SS Pipe / Fixture Made of Resin

Using thin-walled stainless steel pipes allows weight reduction and structural rigidity.

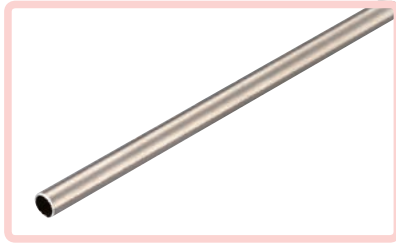

Jungle gym • SS pipe ϕ 8

| | |
|----------------|------------------|
| Order code No. | 340905 |
| Standard | 8*0.6*500 |

● Weight : 56g

| | |
|----------------|-------------------|
| Order code No. | 340906 |
| Standard | 8*0.6*1000 |

● Weight : 112g

| | |
|----------------|-------------------|
| Order code No. | 340907 |
| Standard | 8*0.6*1500 |

● Weight : 144g

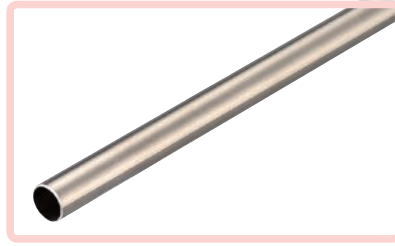

Jungle gym • SS pipe ϕ 12

| | |
|----------------|-------------------|
| Order code No. | 271527 |
| Standard | 12*0.6*500 |

● Weight : 88g

| | |
|----------------|--------------------|
| Order code No. | 271528 |
| Standard | 12*0.6*1000 |

● Weight : 194g

| | |
|----------------|--------------------|
| Order code No. | 271529 |
| Standard | 12*0.6*1500 |

● Weight : 258g

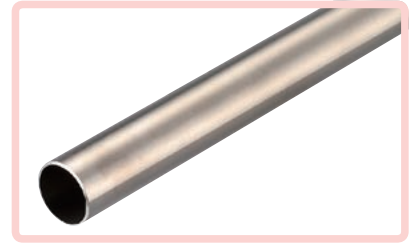

Jungle gym • SS pipe ϕ 20

| | |
|----------------|-------------------|
| Order code No. | 281812 |
| Standard | 20*0.8*500 |

● Weight : 187g

| | |
|----------------|--------------------|
| Order code No. | 281813 |
| Standard | 20*0.8*1000 |

● Weight : 402g

| | |
|----------------|--------------------|
| Order code No. | 281814 |
| Standard | 20*0.8*1500 |

● Weight : 612g

■ Specification

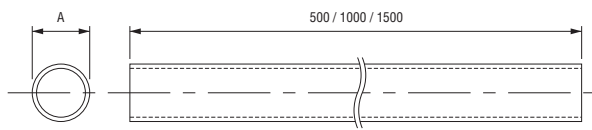

| Product name | A | Thickness | Material | Outside diameter tolerance |
|--------------------------------|-----------|-----------|----------|----------------------------|
| Jungle gym • SS pipe ϕ 8 | ϕ 8 | 0.6mm | SS304 | ± 0.05 |
| Jungle gym • SS pipe ϕ 12 | ϕ 12 | | | |
| Jungle gym • SS pipe ϕ 20 | ϕ 20 | 0.8mm | | |

Frame / Module • Jungle Gym



Tie wrap base ϕ 12 (tie band)

| | |
|----------------|---------------|
| Order code No. | 171210 |
| Standard | RCA12 |

● Weight : 5g

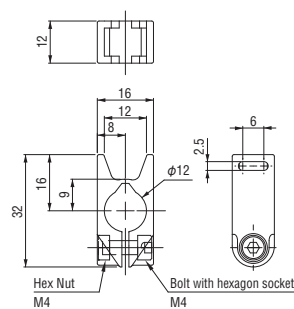

Tie wrap base ϕ 20 (tie band)

| | |
|----------------|---------------|
| Order code No. | 171211 |
| Standard | RCA20 |

● Weight : 7g

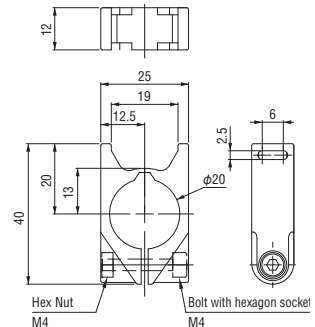

Tie wrap base ϕ 12 (M4)

| | |
|----------------|---------------|
| Order code No. | 171212 |
| Standard | RCB12 |

● Weight : 6g

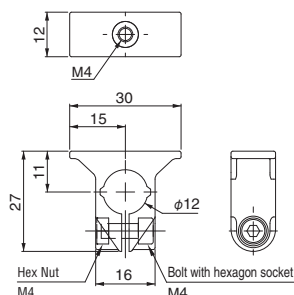

Tie wrap base ϕ 20 (M4)

| | |
|----------------|---------------|
| Order code No. | 171213 |
| Standard | RCB20 |

● Weight : 9g

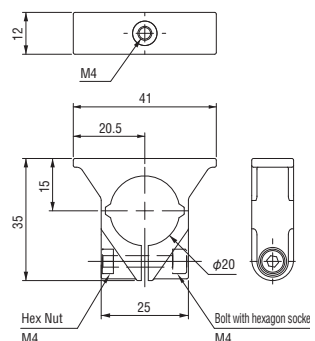

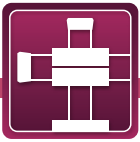

Pipe End Cap / SS Pipe Cutter / Clip

Cap for SS pipe, SS pipe cutter, and clip.

● Use Semedine Super X Series to fix the pipe end cap to jungle gym SS pipe.



Pipe end cap $\phi 8$

| | |
|----------------|------------|
| Order code No. | 131212 |
| Standard | N01902-003 |

● Weight : 0.2g

Pipe end cap $\phi 12$

| | |
|----------------|------------|
| Order code No. | 131211 |
| Standard | N01902-002 |

● Weight : 0.4g

Pipe end cap $\phi 20$

| | |
|----------------|------------|
| Order code No. | 131210 |
| Standard | N01902-001 |

● Weight : 3.0g



SS pipe cutter

| | |
|----------------|--------|
| Order code No. | 101206 |
| Standard | K-203 |

● Weight : 205g

SS pipe cutter blade

| | |
|----------------|---------|
| Order code No. | 101207 |
| Standard | K-203-1 |



Clip · TMA · $\phi 20 * \phi 20$

| | |
|----------------|----------------|
| Order code No. | 196559 |
| Standard | TMA-CL (20*20) |

● Weight : 270g

Clip · TMA · $\phi 20 * \phi 12$

| | |
|----------------|----------------|
| Order code No. | 196560 |
| Standard | TMA-CL (20*12) |

● Weight : 160g

Clip · TMA · $\phi 12 * \phi 12$

| | |
|----------------|----------------|
| Order code No. | 196561 |
| Standard | TMA-CL (12*12) |

● Weight : 75g

Clip · TMA · $\phi 12 * \phi 8$

| | |
|----------------|---------------|
| Order code No. | 196562 |
| Standard | TMA-CL (12*8) |

● Weight : 85g

Clip · TMA · $\phi 8 * \phi 8$

| | |
|----------------|--------------|
| Order code No. | 196563 |
| Standard | TMA-CL (8*8) |

● Weight : 55g

Clip · TMA · $\phi 12 * \phi 10$

| | |
|----------------|----------------|
| Order code No. | 196564 |
| Standard | TMA-CL (12*10) |

● Weight : 62g

196559

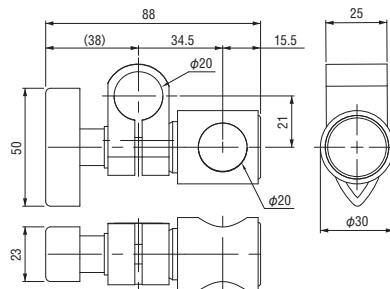

196560

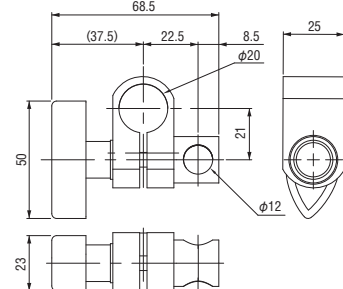

196561

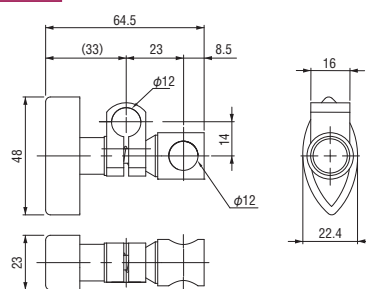

196562

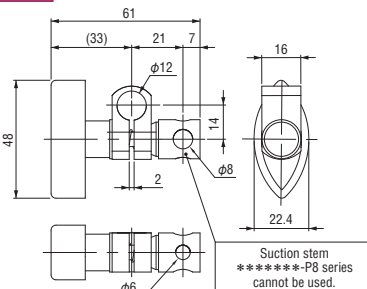

196563

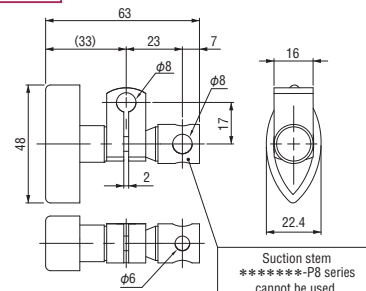

196564

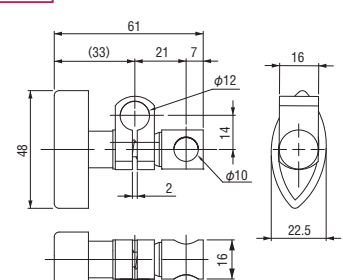

Quick Chuck Change

Quick Chuck Change (Manual)

Tool Changer

Automated Chuck Exchange System

Grip

Mini Cylinder

Accessories for Mini Cylinder

Container Cylinders

Accessories for Container Cylinder

Grippers

Buffer Material

Suction

Suction Cups

Suction Stem

Pad in Pad

Air Ejector / Filter / Check Valve

Micro Mold E.O.A.T

Cut

Mini Air Nippers

Air Nippers

Frame/Module

Jungle Gym

Let's Joint

Rectangular Tube

Base Aluminum Material

Sliding Chuck

Tubing/Sensors

Tubing

Sensors

Other Products

Others

Information

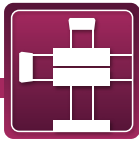

Jungle Gym Series Parts

Various parts can be attached to jungle gym based on SS pipe ($\phi 8$ / $\phi 12$ / $\phi 20$).

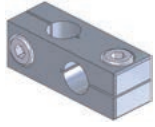

Cross connector • $\phi 8 \phi 8$

Order code No. **131102**
Standard **N01861-207**

● Weight : 9.0g

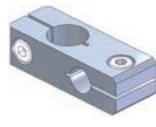
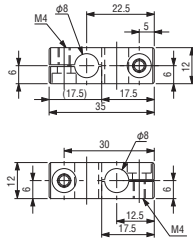

Cross connector • $\phi 12 \phi 8$

Order code No. **131098**
Standard **N01861-201**

● Weight : 16.8g

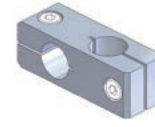
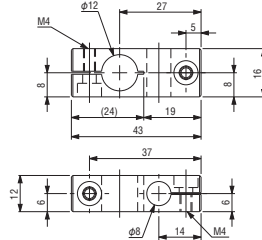

Cross connector • $\phi 12 \phi 12$

Order code No. **131099**
Standard **N01861-202**

● Weight : 20.5g

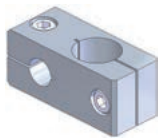
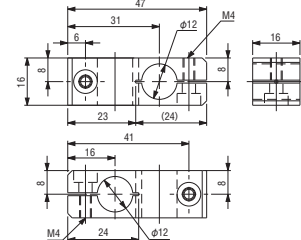

Cross connector • $\phi 20 \phi 12$

Order code No. **131100**
Standard **N01861-204**

● Weight : 72.0g

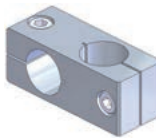
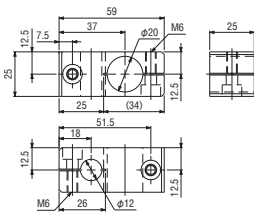

Cross connector • $\phi 20 \phi 20$

Order code No. **131101**
Standard **N01861-206**

● Weight : 50.3g

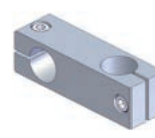
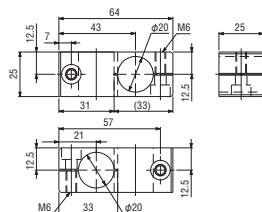

Cross connector long • $\phi 20 \phi 20$

Order code No. **131573**
Standard **N01861-206B**

● Weight : 109.0g

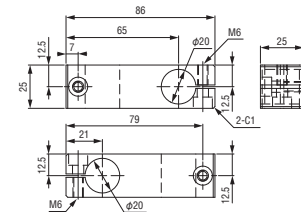

► Convenient for addition of components after assembly.

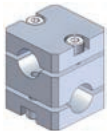

Cross connector • $\phi 12 \phi 12$ (rear entrance)

Order code No. **131569**
Standard **N01861-202A**

● Weight : 11.1g

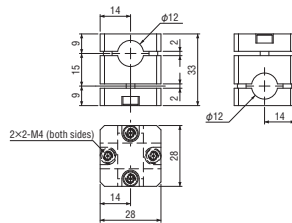

► Convenient for addition of components after assembly.

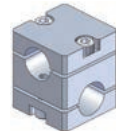

Cross connector • $\phi 20 \phi 20$ (rear entrance)

Order code No. **131570**
Standard **N01861-206A**

● Weight : 30.0g

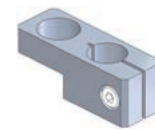
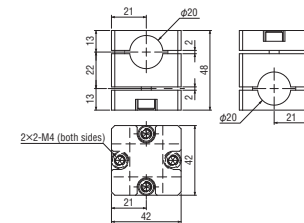

Connector • for SSW

Order code No. **131097**
Standard **N01861-108**

● Weight : 15.5g

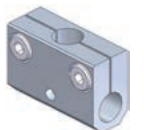
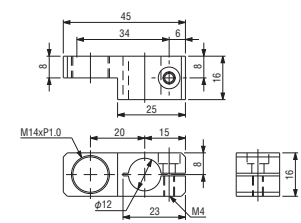

T Connector #1 • $\phi 8 \phi 8$

Order code No. **131108**
Standard **N01861-306**

● Weight : 12.5g

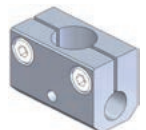
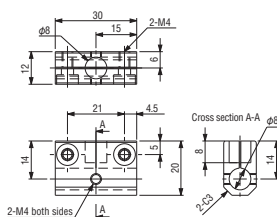

T Connector #1 • $\phi 8 \phi 12$

Order code No. **131105**
Standard **N01861-303**

● Weight : 22.6g

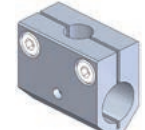
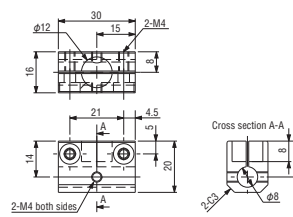

T Connector #1 • $\phi 12 \phi 8$

Order code No. **131104**
Standard **N01861-302**

● Weight : 18.7g

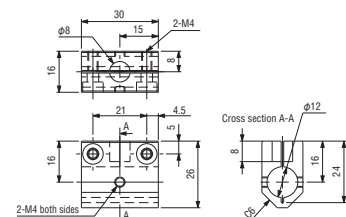

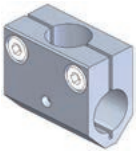

**T Connector # 1 •
φ12 φ12**

Order code No. **131103**
Standard **N01861-301**

● Weight : 17.5g

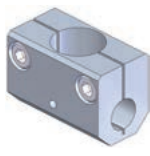
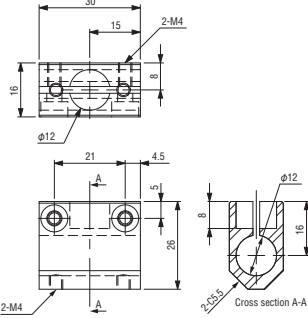

**T Connector # 1 •
φ12 φ20**

Order code No. **131109**
Standard **N01861-307**

● Weight : 57.8g

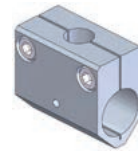
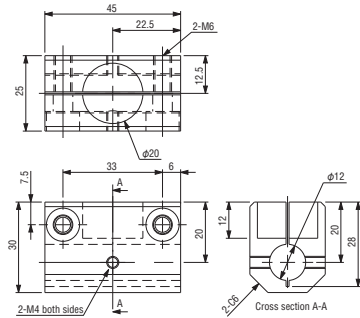

**T Connector # 1 •
φ20 φ12**

Order code No. **131106**
Standard **N01861-304**

● Weight : 62.4g

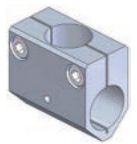
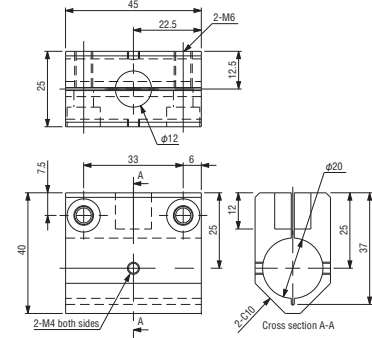

**T Connector # 1 •
φ20 φ20**

Order code No. **131107**
Standard **N01861-305**

● Weight : 55.9g

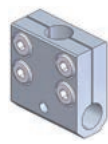
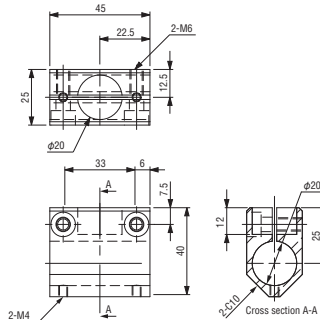

**T Connector # 2 •
φ8 φ8**

Order code No. **131115**
Standard **N01861-406**

● Weight : 14.6g

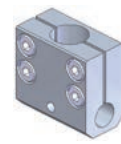
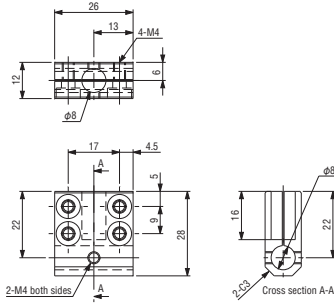

**T Connector # 2 •
φ8 φ12**

Order code No. **131112**
Standard **N01861-403**

● Weight : 30.8g

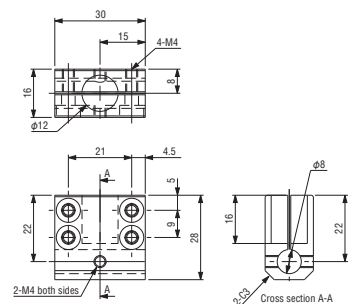

**T Connector # 2 •
φ12 φ8**

Order code No. **131111**
Standard **N01861-402**

● Weight : 28.3g

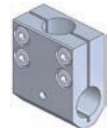
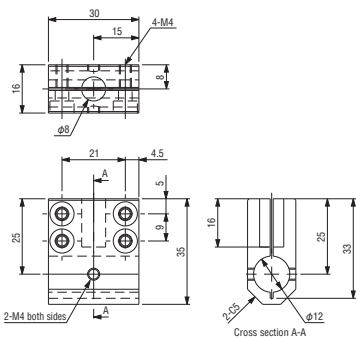

**T Connector # 2 •
φ12 φ12**

Order code No. **131110**
Standard **N01861-401**

● Weight : 25.7g

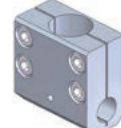
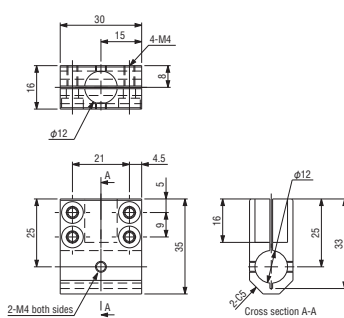

**T Connector # 2 •
φ12 φ20**

Order code No. **131116**
Standard **N01861-407**

● Weight : 87.2g

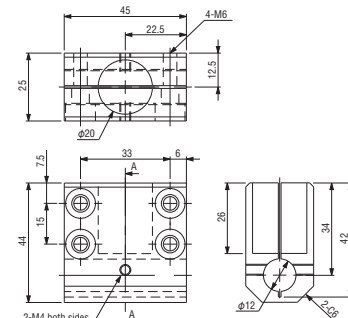

Quick Chuck Change

Quick Chuck Change (Manual)

Tool Changer

Automated Chuck Exchange System

Grip

Mini Cylinder

Accessories for Mini Cylinder

Container Cylinders

Accessories for Container Cylinder

Grippers

Buffer Material

Suction

Suction Cups

Suction Stem

Pad in Pad

Air Ejector/Filter/Check Valve

Micro Mold E.O.A.T

Cut

Mini Air Nippers

Air Nippers

Frame/Module

Jungle Gym

Let's Joint

Rectangular Tube

Base Aluminum Material

Sliding Chuck

Tubing/Sensors

Tubing

Sensors

Other Products

Others

Information

Jungle Gym Series Parts

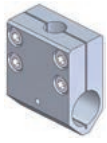

**T Connector # 2 •
φ20 φ12**
Order code No. **131113**
Standard **N01861-404**
● Weight : 107.4g

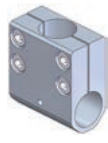
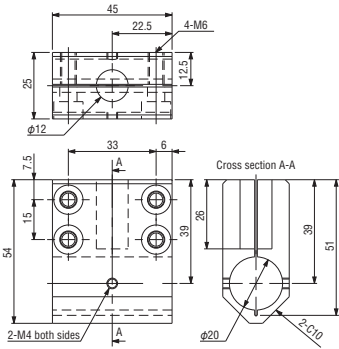

**T Connector # 2 •
φ20 φ20**
Order code No. **131114**
Standard **N01861-405**
● Weight : 77.3g

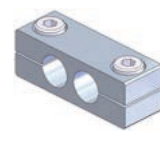
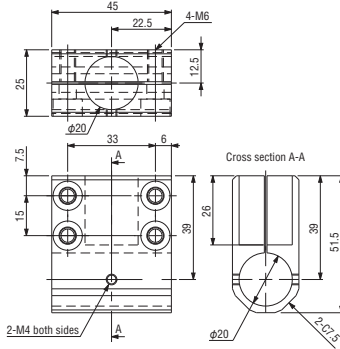

**Parallel connector •
φ8 φ8**
Order code No. **131096**
Standard **N01861-107**
● Weight : 9.1g

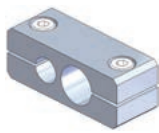
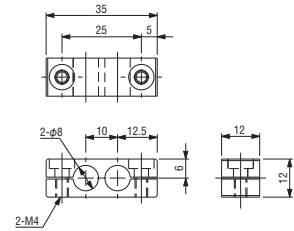

**Parallel connector •
φ8 φ12**
Order code No. **131092**
Standard **N01861-101**
● Weight : 20.6g

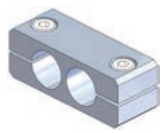
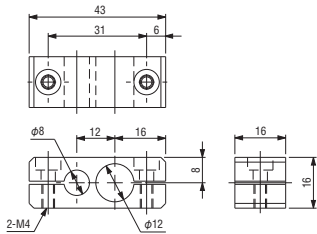

**Parallel connector •
φ12 φ12**
Order code No. **131093**
Standard **N01861-102**
● Weight : 18.6g

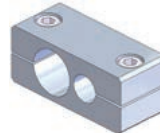
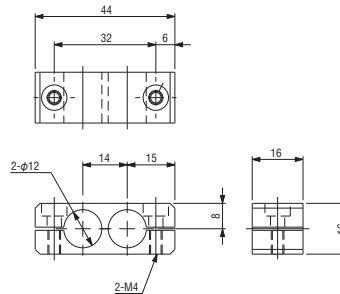

**Parallel connector •
φ20 φ12**
Order code No. **131094**
Standard **N01861-104**
● Weight : 67.2g

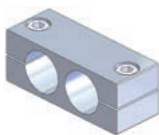
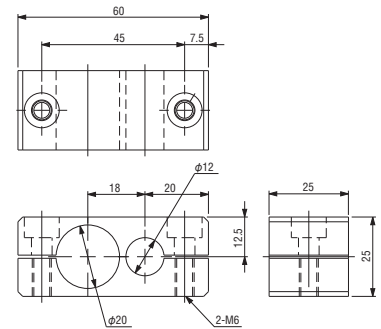

**Parallel connector •
φ20 φ20**
Order code No. **131095**
Standard **N01861-106**
● Weight : 60.7g

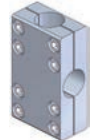
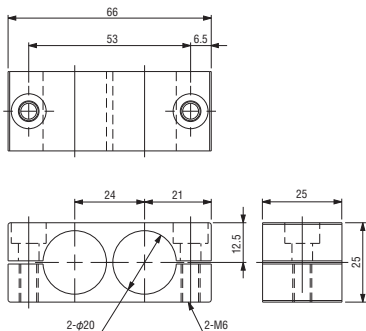

**Cross connector # 2 •
φ20 φ20**
Order code No. **131117**
Standard **N01861-501**
● Weight : 132.3g

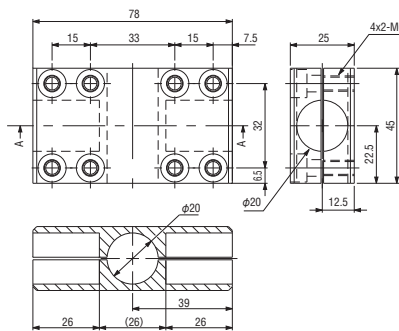

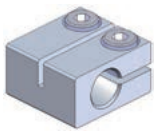

Straight connector • $\phi 8$

Order code No. **131488**
Standard **N01868-501**

● Weight : 12.2g

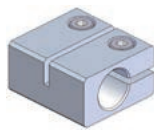
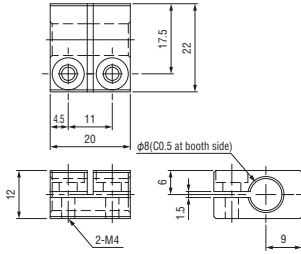

Straight connector • $\phi 12$

Order code No. **131489**
Standard **N01868-502**

● Weight : 26.8g

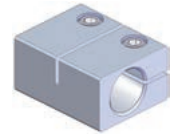
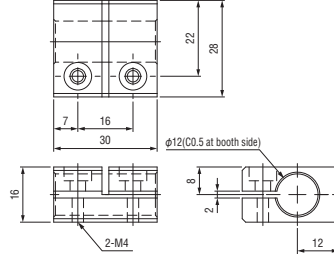

Straight connector • $\phi 20$

Order code No. **131490**
Standard **N01868-503**

● Weight : 102.1g

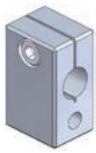
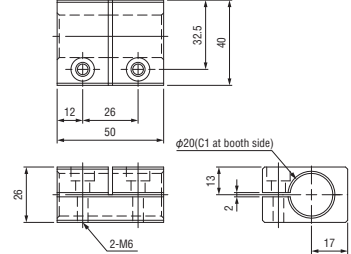

Access bracket • $\phi 12 \cdot M6$

Order code No. **131125**
Standard **N01862-210**

● Weight : 41.5g

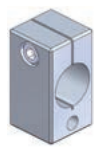
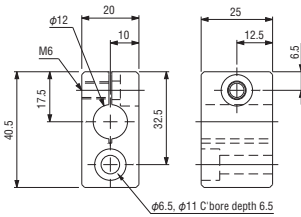

Access bracket • $\phi 20 \cdot M6$

Order code No. **131126**
Standard **N01862-211**

● Weight : 50.8g

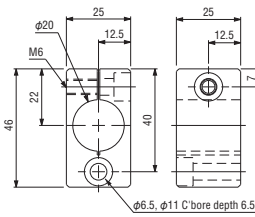

Attachment bracket • $\phi 8 \cdot M5$

Order code No. **131306**
Standard **N01862-208**

● Weight : 15.0g

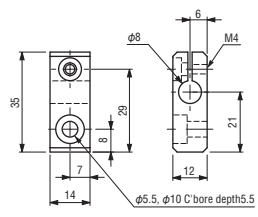

Attachment bracket • $\phi 8 \cdot M6$

Order code No. **131121**
Standard **N01862-205**

● Weight : 11.1g

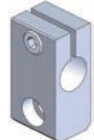
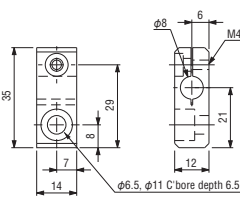

Attachment bracket • $\phi 12 \cdot M5$

Order code No. **131305**
Standard **N01862-204**

● Weight : 30.0g

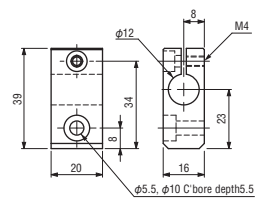

Attachment bracket • $\phi 12 \cdot M6$

Order code No. **131118**
Standard **N01862-201**

● Weight : 24.1g

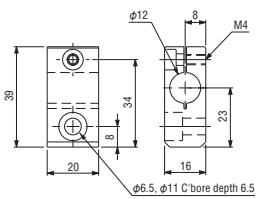

Attachment bracket • $\phi 12 \cdot M8$

Order code No. **131225**
Standard **N01862-213**

● Weight : 41.5g

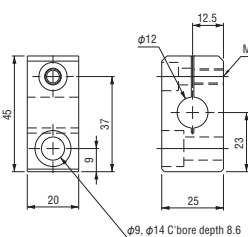

Attachment bracket • $\phi 20 \cdot M6$

Order code No. **131123**
Standard **N01862-207**

● Weight : 44.7g

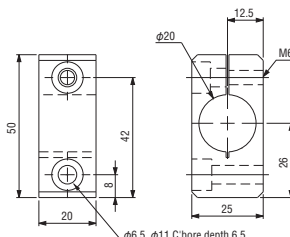

Attachment bracket • $\phi 20 \cdot M8$

Order code No. **131226**
Standard **N01862-214**

● Weight : 50.7g

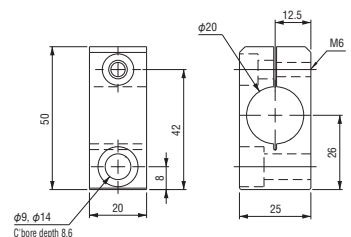

Quick Chuck Change

Quick Chuck Change (Manual)

Tool Changer

Automated Chuck Exchange System

Grip

Mini Cylinder

Accessories for Mini Cylinder

Container Cylinders

Accessories for Container Cylinder

Grippers

Buffer Material

Suction

Suction Cups

Suction Stem

Pad in Pad

Air Ejector / Filter / Check Valve

Micro Mold E.O.A.T

Cut

Mini Air Nippers

Air Nippers

Frame/Module

Jungle Gym

Let's Joint

Rectangular Tube

Base Aluminum Material

Sliding Chuck

Tubing/Sensors

Tubing

Sensors

Other Products

Others

Information

Jungle Gym Series Parts

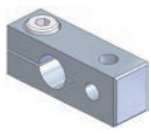

Suction bracket •
φ 8 • M5

Order code No. **131122**
Standard **N01862-206**

● Weight : 8.1g

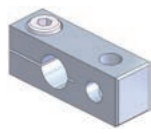
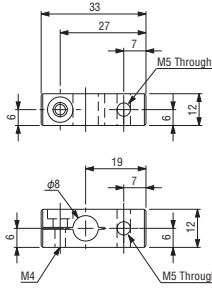

Suction bracket •
φ 8 • M6

Order code No. **131124**
Standard **N01862-209**

● Weight : 7.8g ● M6 fine

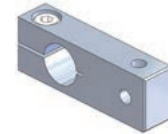
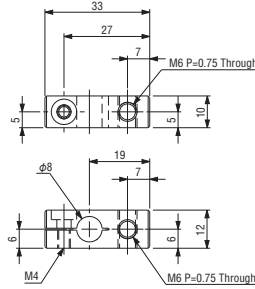

Suction bracket •
φ 12 • M5

Order code No. **131119**
Standard **N01862-202**

● Weight : 15.7g

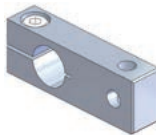
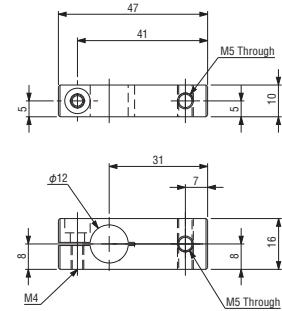

Suction bracket •
φ 12 • M6

Order code No. **131127**
Standard **N01862-212**

● Weight : 15.4g ● M6 fine

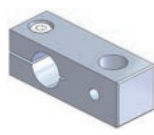
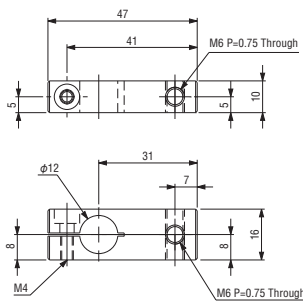

Suction bracket •
φ 12 • PT1/8

Order code No. **131120**
Standard **N01862-203**

● Weight : 24.1g

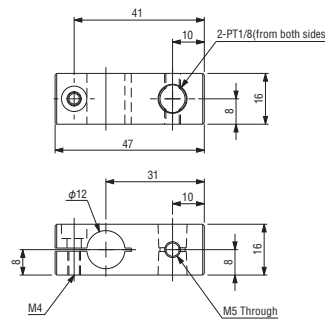

Cylinder bracket •
φ 8

Order code No. **131075**
Standard **N01915-113**

● Weight : 106.2g

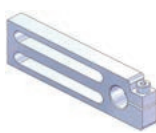
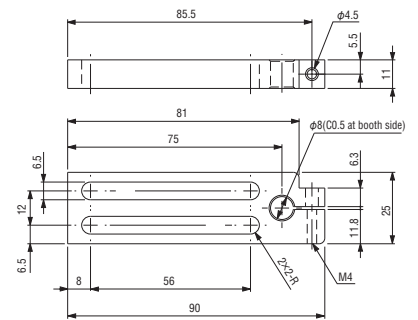

Cylinder bracket •
φ 12

Order code No. **131074**
Standard **N01915-112**

● Weight : 111.1g

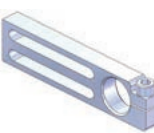
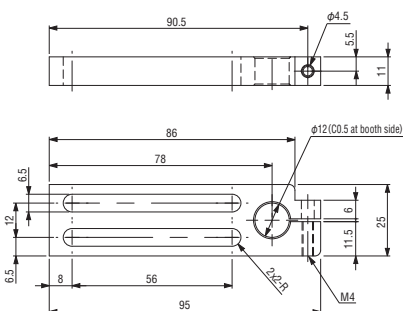

Cylinder bracket •
φ 20

Order code No. **131066**
Standard **N01915-103**

● Weight : 111.6g

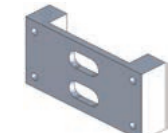
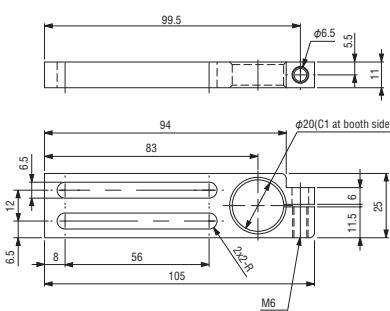

Swing bracket

Order code No. **131065**
Standard **N01915-102**

● Weight : 32.1g

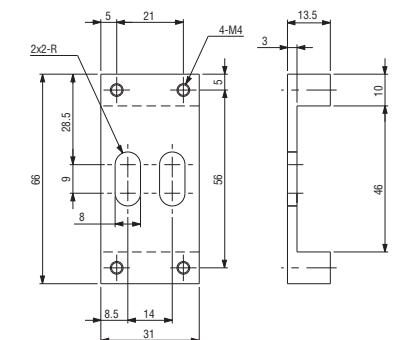

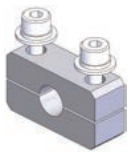

Slide bracket · $\phi 8$

Order code No. **131151**
Standard **N01863-207**

● Weight : 10.4g

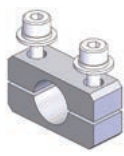

Slide bracket · $\phi 12$

Order code No. **131145**
Standard **N01863-201**

● Weight : 8.5g

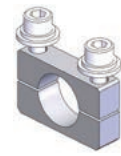

Slide bracket · $\phi 20$

Order code No. **131149**
Standard **N01863-205**

● Weight : 15.0g

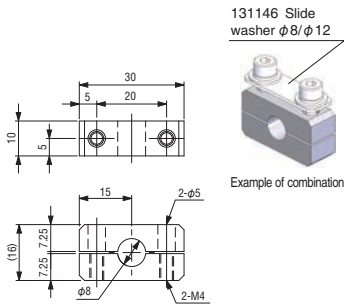

131146 Slide washer $\phi 8/\phi 12$

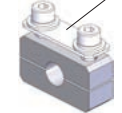

Example of combination

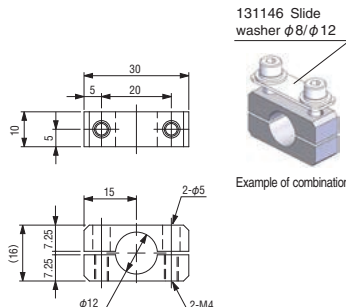

131146 Slide washer $\phi 8/\phi 12$

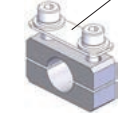

Example of combination

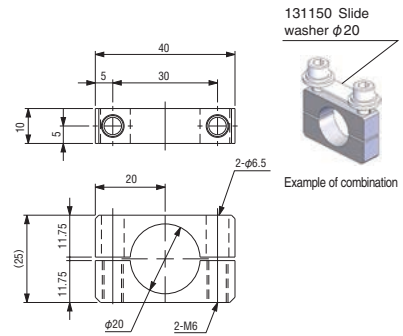

131150 Slide washer $\phi 20$

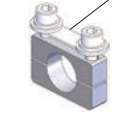

Example of combination

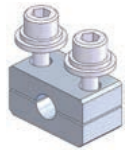

Slide bracket · W · $\phi 8$

Order code No. **131217**
Standard **N01863-113**

● Weight : 12.0g

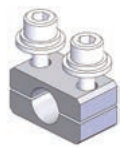

Slide bracket · W · $\phi 12$

Order code No. **131128**
Standard **N01863-101**

● Weight : 13.3g

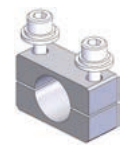

Slide bracket · W · $\phi 20$

Order code No. **131134**
Standard **N01863-111**

● Weight : 26.2g

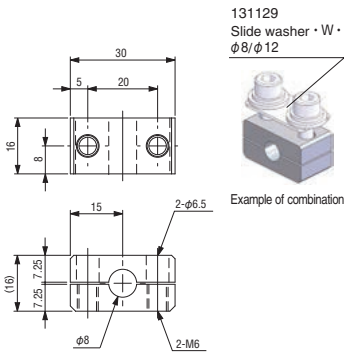

131129 Slide washer · W · $\phi 8/\phi 12$

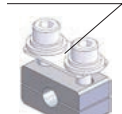

Example of combination

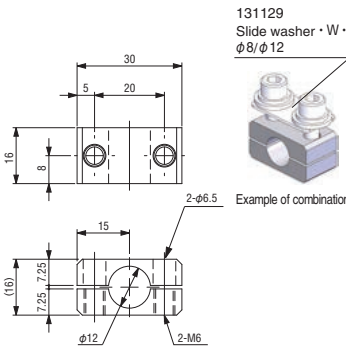

131129 Slide washer · W · $\phi 8/\phi 12$

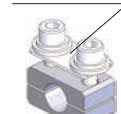

Example of combination

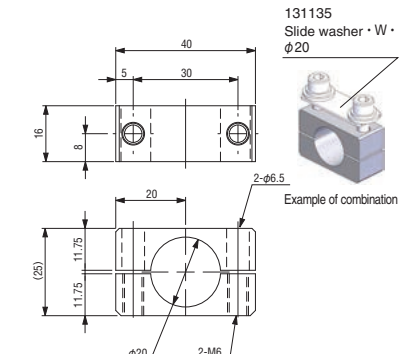

131135 Slide washer · W · $\phi 20$

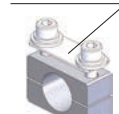

Example of combination

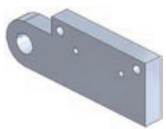

Sensor bracket · $\phi 12$

Order code No. **131189**
Standard **N01867-101**

● Weight : 9.2g

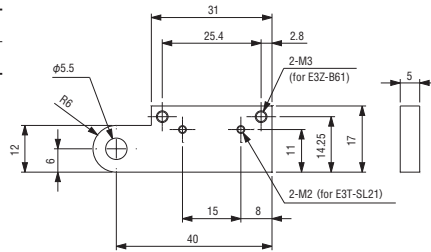

Sensor Mounting Example ①

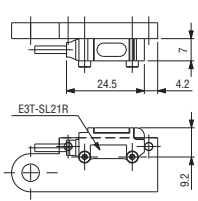
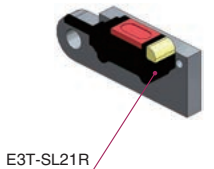

Sensor Mounting Example ②

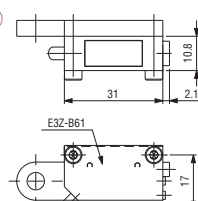
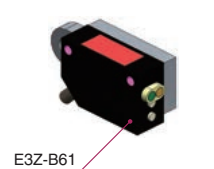

Quick Chuck Change

Quick Chuck Change (Manual)

Tool Changer

Automated Chuck Exchange System

Grip

Mini Cylinder

Accessories for Mini Cylinder

Container Cylinders

Accessories for Container Cylinder

Grippers

Buffer Material

Suction

Suction Cups

Suction Stem

Pad in Pad

Air Ejector/Filter/Check Valve

Micro Mold E.O.A.T

Cut

Mini Air Nippers

Air Nippers

Frame/Module

Jungle Gym

Let's Joint

Rectangular Tube

Base Aluminum Material

Sliding Chuck

Tubing/Sensors

Tubing

Sensors

Other Products

Others

Information

Jungle Gym Series Parts

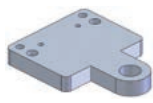

Sensor bracket

| | |
|----------------|-------------------|
| Order code No. | 131077 |
| Standard | N01915-201 |

● Weight : 12.6g

Sensor Mounting Example ①



Sensor Mounting Example ②

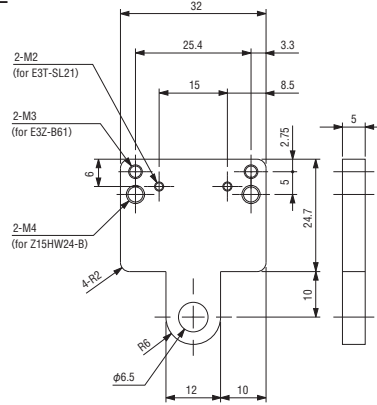
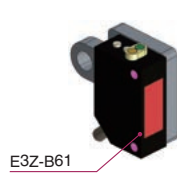

Chuck bracket • TH • φ8

| | |
|----------------|-------------------|
| Order code No. | 131188 |
| Standard | N01866-502 |

● Weight : 8.6g
● If base frame φ8 is used, this product may be loosened and rotated.

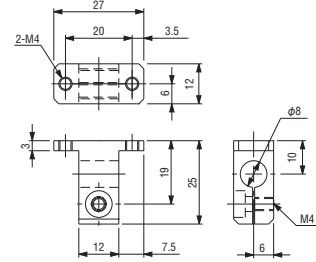

Chuck bracket • TH • φ12

| | |
|----------------|-------------------|
| Order code No. | 131187 |
| Standard | N01866-501 |

● Weight : 18.3g

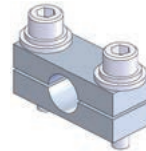
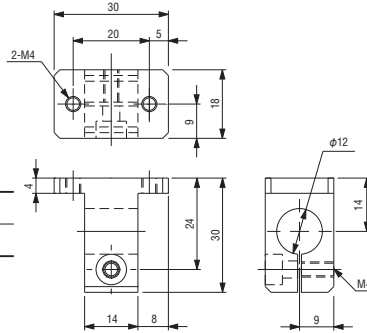

Chuck bracket • φ12

| | |
|----------------|-------------------|
| Order code No. | 131067 |
| Standard | N01915-105 |

● Weight : 19.6g

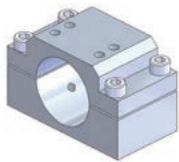
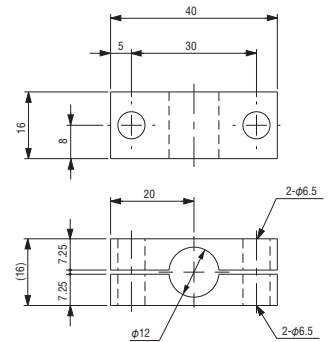

Nipper bracket • A

| | |
|----------------|-------------------|
| Order code No. | 131078 |
| Standard | N01915-301 |

● Weight : 208.8g

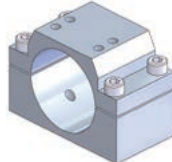
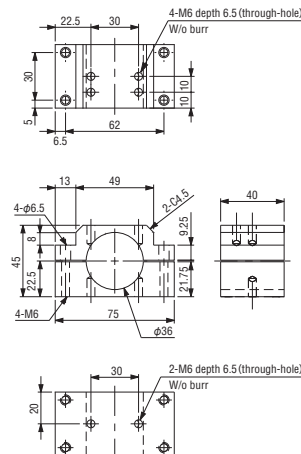

Nipper bracket • B

| | |
|----------------|-------------------|
| Order code No. | 131216 |
| Standard | N01915-302 |

● Weight : 198.4g

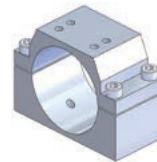
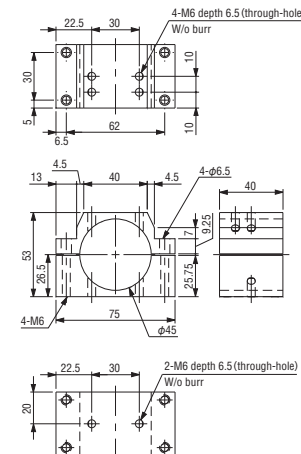

Nipper bracket • C

| | |
|----------------|-------------------|
| Order code No. | 131080 |
| Standard | N01915-303 |

● Weight : 241.3g

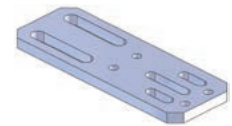
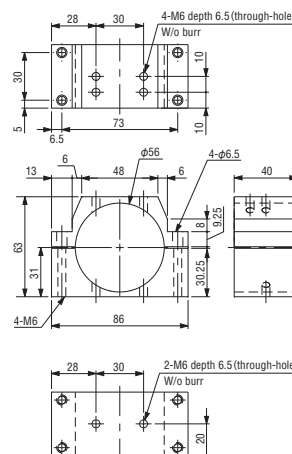

Nipper bracket • D

| | |
|----------------|-------------------|
| Order code No. | 131081 |
| Standard | N01915-304 |

● Weight : 109.4g
● for NW-10, NW-20, GT-NT3

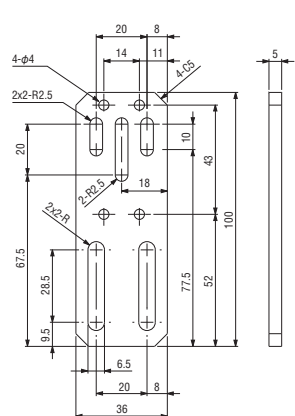



Nipper bracket • E

Order code No. **131082**
Standard **N01915-305**

- Weight : 214.0g
- for NW-35, GT-NT05, GT-NT10, GT-NT20

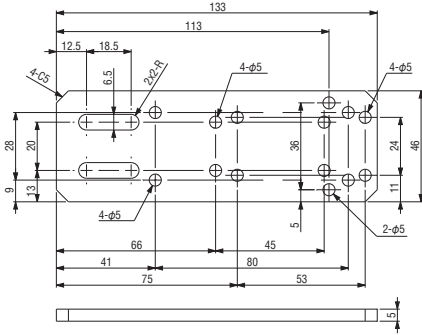

Bracket • L • ϕ 8 • for UMCD

Order code No. **131180**
Standard **N01866-202**

- Weight : 9.3g
- If base frame ϕ 8 is used, this product may be loosened and rotated.
- Check bolt length.

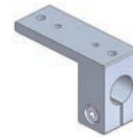
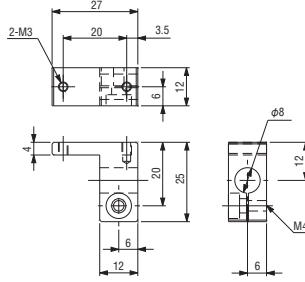

Bracket • L • ϕ 12 • for MCD

Order code No. **131179**
Standard **N01866-201**

- Weight : 21.8g
- Check bolt length.

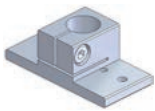
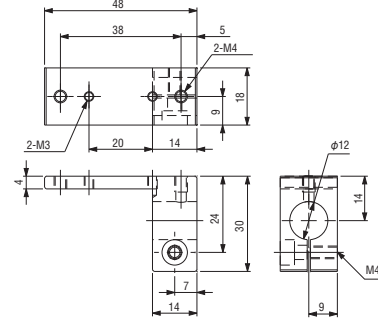

Bracket • T • ϕ 12 • for MCD

Order code No. **131176**
Standard **N01866-101**

- Weight : 19.3g

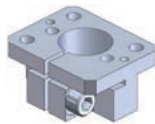
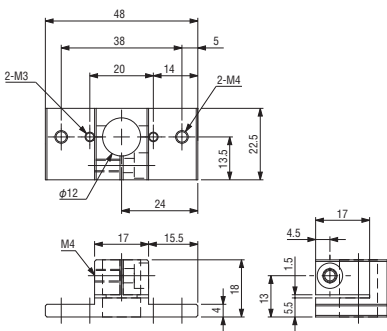

Bracket • T • ϕ 20 • for MCD

Order code No. **131554**
Standard **N01866-103A**

- Weight : 49.0g

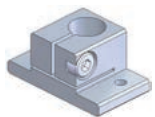
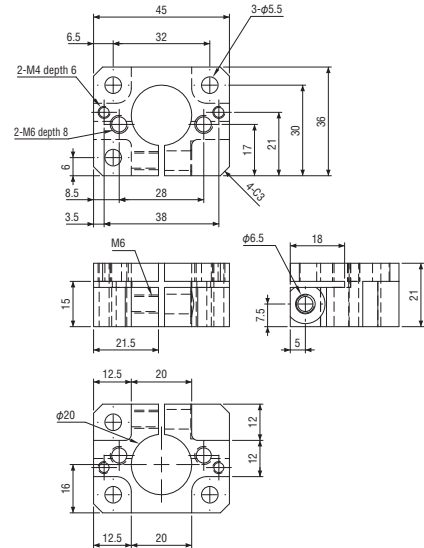

Bracket • T • ϕ 8 • for UMCD

Order code No. **131177**
Standard **N01866-102**

- Weight : 6.1g
- If base frame ϕ 8 is used, this product may be loosened and rotated.

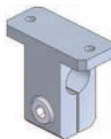
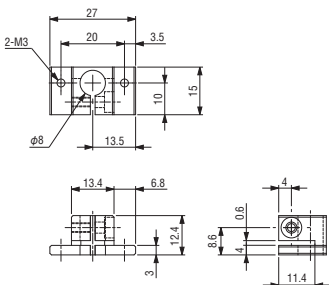

Bracket • TH • ϕ 8 • for UMCD

Order code No. **131182**
Standard **N01866-302**

- Weight : 8.2g
- If base frame ϕ 8 is used, this product may be loosened and rotated.
- Check bolt length.

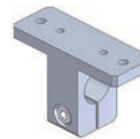
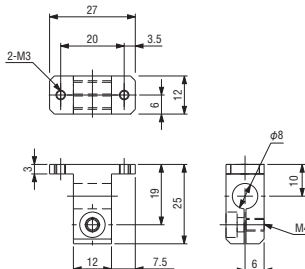

Bracket • TH • ϕ 12 • for MCD

Order code No. **131181**
Standard **N01866-301**

- Weight : 21.8g
- Check bolt length.

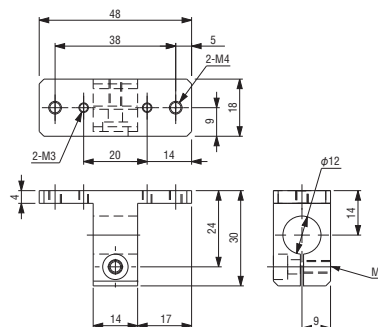

Quick Chuck Change

Quick Chuck Change (Manual)

Tool Changer

Automated Chuck Exchange System

Grip

Mini Cylinder

Accessories for Mini Cylinder

Container Cylinders

Accessories for Container Cylinder

Grippers

Buffer Material

Suction

Suction Cups

Suction Stem

Pad in Pad

Air Ejector/Filter/Check Valve

Micro Mold E.O.A.T

Cut

Mini Air Nippers

Air Nippers

Frame/Module

Jungle Gym

Let's Joint

Rectangular Tube

Base Aluminum Material

Sliding Chuck

Tubing/Sensors

Tubing

Sensors

Other Products

Others

Information

Jungle Gym Series Parts

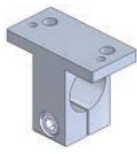

Bracket • TH • φ 20 • for UMCD

| | |
|----------------|-------------------|
| Order code No. | 131183 |
| Standard | N01866-303 |

- Weight : 40.6g
- Check the length of mounting bolt for mini cylinder.
- There may be interference between pipe and bolt when you attach mini container cylinder.

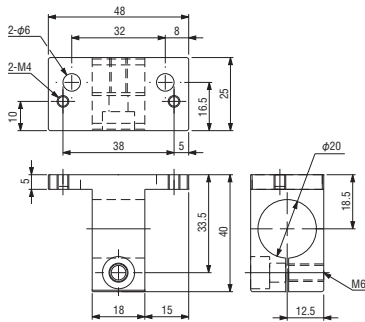

Bracket • TV • φ 8 • for UMCD

| | |
|----------------|-------------------|
| Order code No. | 131185 |
| Standard | N01866-402 |

- Weight : 8.7g
- If base frame φ 8 is used, this product may be loosened and rotated.

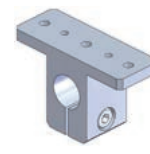
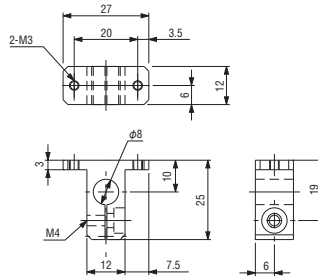

Bracket • TV • φ 12 • for MCD

| | |
|----------------|-------------------|
| Order code No. | 131184 |
| Standard | N01866-401 |

- Weight : 25.6g

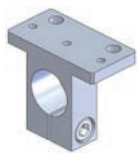
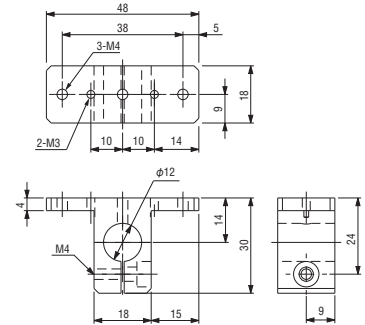

Bracket • TV • φ 20 • for MCD

| | |
|----------------|-------------------|
| Order code No. | 131186 |
| Standard | N01866-403 |

- Weight : 35.9g

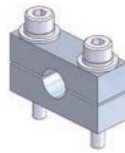
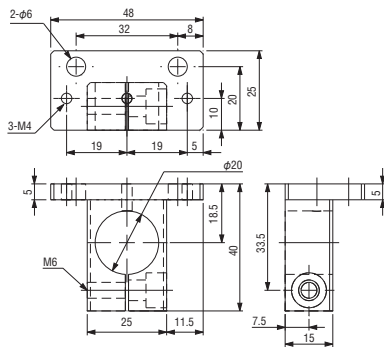

Bracket • φ 8

| | |
|----------------|-------------------|
| Order code No. | 131073 |
| Standard | N01915-111 |

- Weight : 10.0g

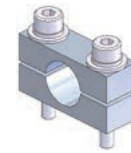
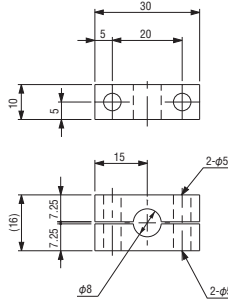

Bracket • φ 12

| | |
|----------------|-------------------|
| Order code No. | 131071 |
| Standard | N01915-109 |

- Weight : 8.2g

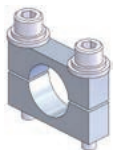
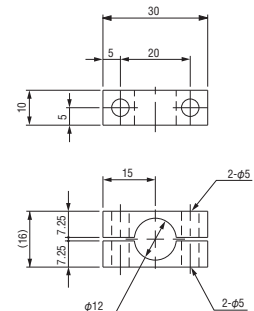

Bracket • φ 20

| | |
|----------------|-------------------|
| Order code No. | 131072 |
| Standard | N01915-110 |

- Weight : 16.1g

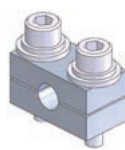
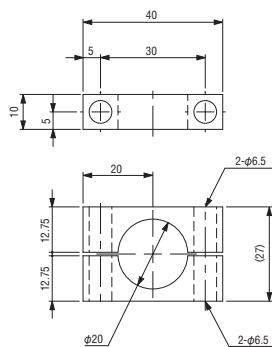

Bracket • W • φ 8

| | |
|----------------|-------------------|
| Order code No. | 131070 |
| Standard | N01915-108 |

- Weight : 15.8g

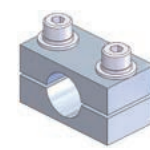
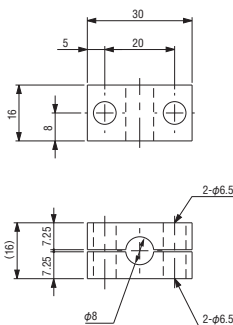

Bracket • W • φ 12

| | |
|----------------|-------------------|
| Order code No. | 131068 |
| Standard | N01915-106 |

- Weight : 12.9g

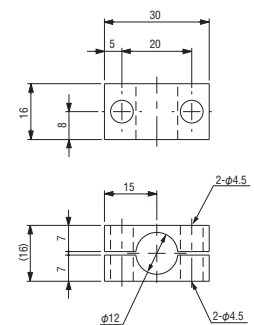

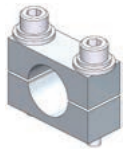

Bracket • W • $\phi 20$

Order code No. **131069**
 Standard **N01915-107**
 ● Weight : 28.6g

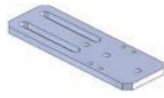
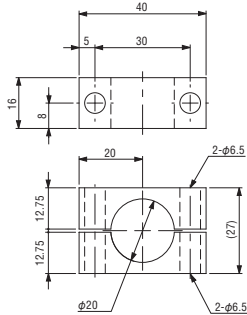

Bracket • NCON

Order code No. **131083**
 Standard **N01915-401**
 ● Weight : 153.7g
 ● for NCON-20W, 40W, 80W

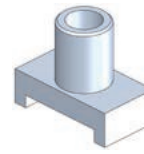
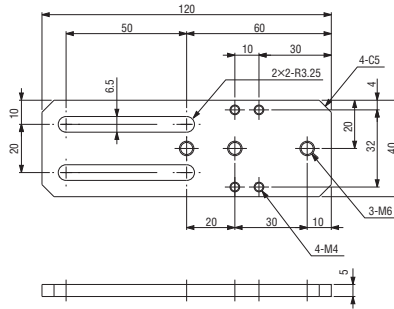

Rotation bracket • $\phi 20$

Order code No. **131064**
 Standard **N01915-101**
 ● Weight : 8.9g

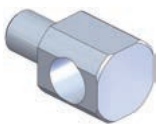
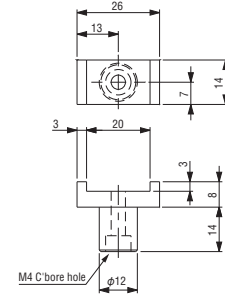

Rotation bracket • M10 • 8A

Order code No. **131172**
 Standard **N01864-305**
 ● Weight : 6.4g

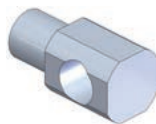
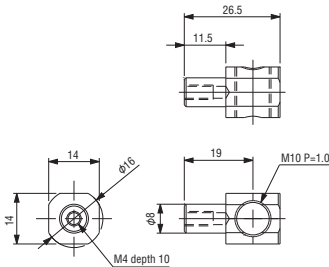

Rotation bracket • M12 • 12A

Order code No. **131173**
 Standard **N01864-306**
 ● Weight : 12.9g

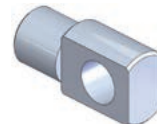
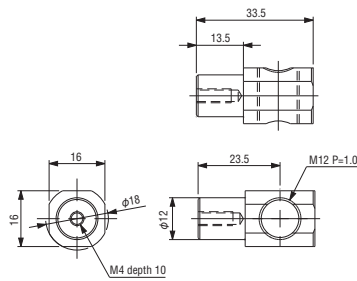

Rotation bracket • M17 • 20A

Order code No. **131174**
 Standard **N01864-307**
 ● Weight : 59.3g

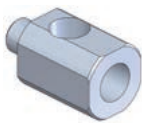
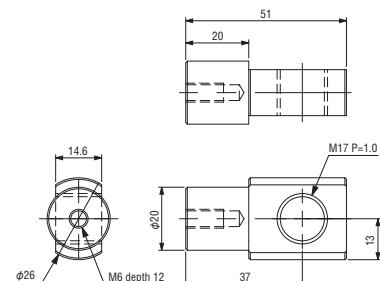

Rotation bracket • PT1/8 • 8A

Order code No. **131175**
 Standard **N01864-401**
 ● Weight : 11.8g

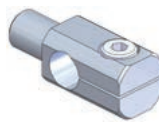
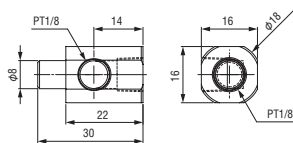

Rotation bracket • $\phi 8$ • 8A

Order code No. **131170**
 Standard **N01864-303**
 ● Weight : 6.6g

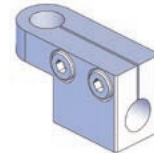
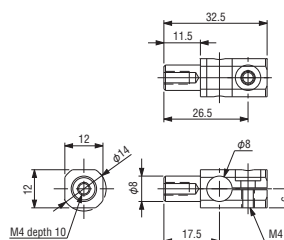

Rotation bracket • $\phi 8$ • 8B

Order code No. **131606**
 Standard **N01864-103A**
 ● Weight : 14.7g

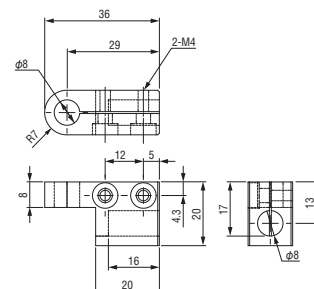

Quick Chuck Change

Quick Chuck Change (Manual)

Tool Changer

Automated Chuck Exchange System

Grip

Mini Cylinder

Accessories for Mini Cylinder

Container Cylinders

Accessories for Container Cylinder

Grippers

Buffer Material

Suction

Suction Cups

Suction Stem

Pad in Pad

Air Ejector/Filter/Check Valve

Micro Mold E.O.A.T

Cut

Mini Air Nippers

Air Nippers

Frame/Module

Jungle Gym

Let's Joint

Rectangular Tube

Base Aluminum Material

Sliding Chuck

Tubing/Sensors

Tubing

Sensors

Other Products

Others

Information

Jungle Gym Series Parts

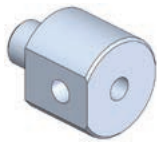

Rotation bracket •
φ 8 • M5A

| | |
|----------------|-------------------|
| Order code No. | 131164 |
| Standard | N01864-202 |

● Weight : 10.0g

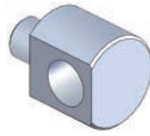
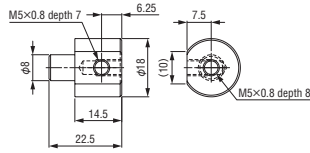

Rotation bracket •
φ 8 • M10A

| | |
|----------------|-------------------|
| Order code No. | 131435 |
| Standard | N01864-201 |

● Weight : 8.2g

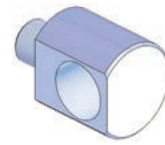
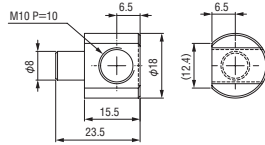

Rotation bracket •
φ 8 • M12A

| | |
|----------------|-------------------|
| Order code No. | 131433 |
| Standard | N01864-205 |

● Weight : 7.6g

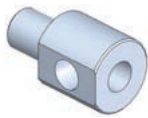
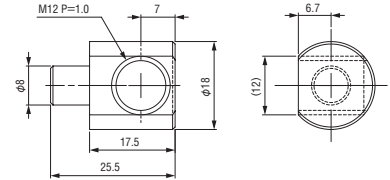

Rotation bracket •
φ 12 • PT1/8A

| | |
|----------------|-------------------|
| Order code No. | 131166 |
| Standard | N01864-204 |

● Weight : 24.6g

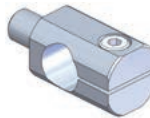
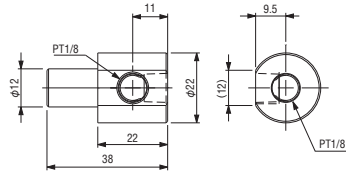

Rotation bracket •
φ 12 • 8A

| | |
|----------------|-------------------|
| Order code No. | 131169 |
| Standard | N01864-302 |

● Weight : 11.9g

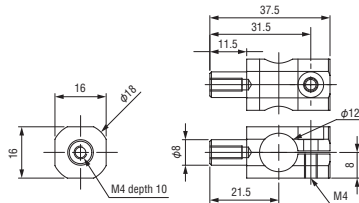

Rotation bracket •
φ 12 • 8B

| | |
|----------------|--------------------|
| Order code No. | 131600 |
| Standard | N01864-101A |

● Weight : 20.6g

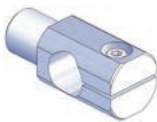
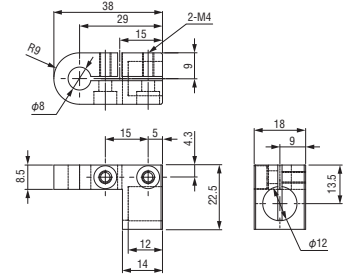

Rotation bracket •
φ 12 • 12A

| | |
|----------------|-------------------|
| Order code No. | 131168 |
| Standard | N01864-301 |

● Weight : 14.6g

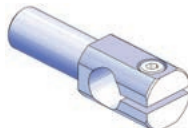
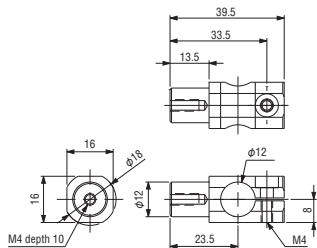

Rotation bracket •
φ 12 • 12AL

| | |
|----------------|--------------------|
| Order code No. | 131567 |
| Standard | N01864-301L |

● Weight : 20.0g

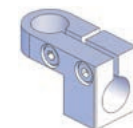
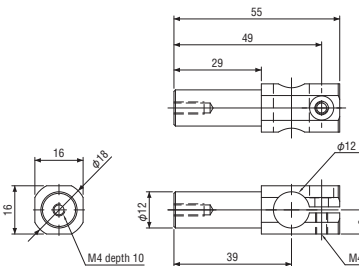

Rotation bracket •
φ 12 • 12B

| | |
|----------------|--------------------|
| Order code No. | 131605 |
| Standard | N01864-102A |

● Weight : 20.0g

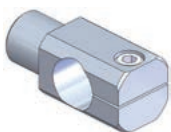
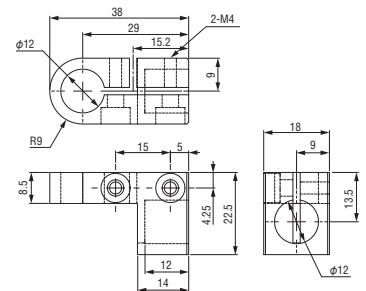

Rotation bracket •
φ 20 • 20A

| | |
|----------------|-------------------|
| Order code No. | 131171 |
| Standard | N01864-304 |

● Weight : 50.7g

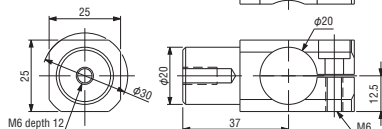

Rotation bracket •
φ 20 • 20AL

| | |
|----------------|--------------------|
| Order code No. | 131568 |
| Standard | N01864-304L |

● Weight : 80.0g

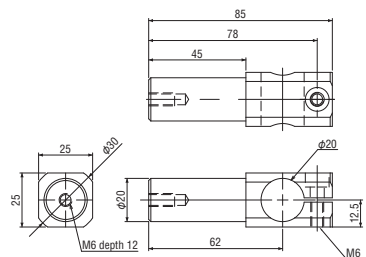

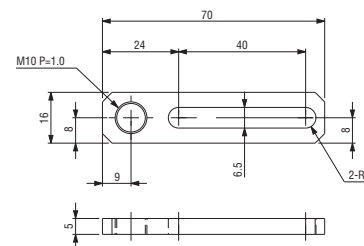
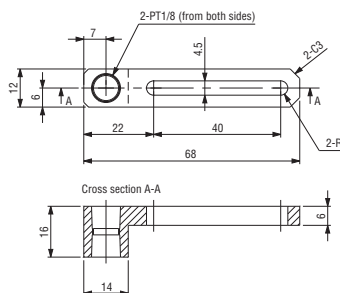
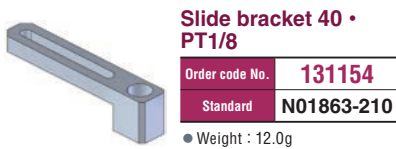
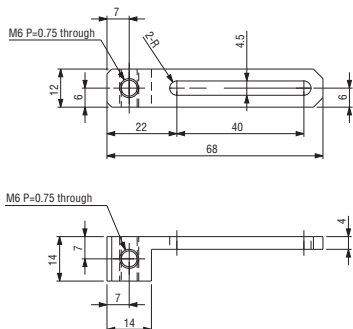
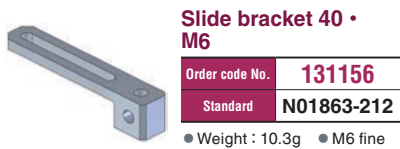
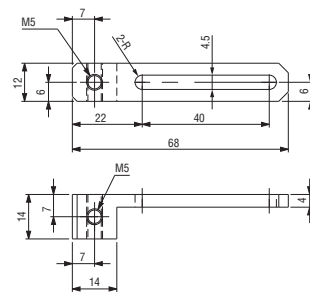
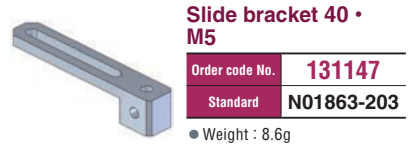
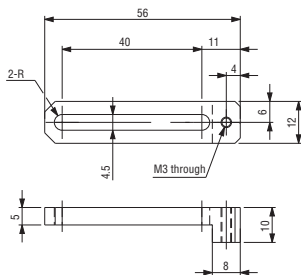
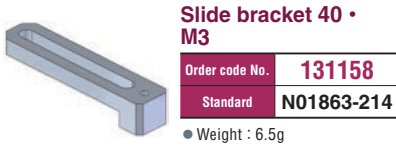
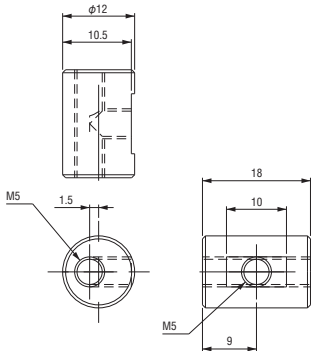
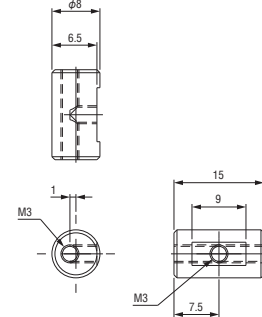
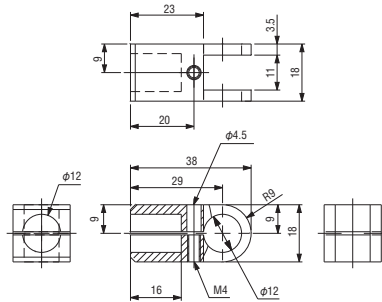
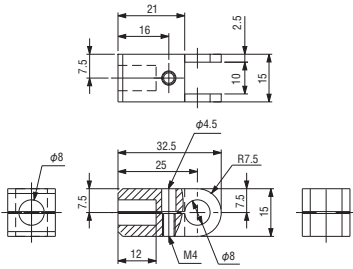
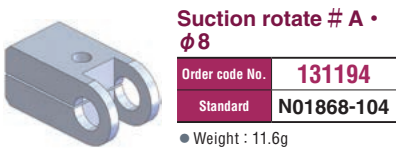

Quick Chuck Change

Quick Chuck Change (Manual)

Tool Changer

Automated Chuck Exchange System

Grip

Mini Cylinder

Accessories for Mini Cylinder

Container Cylinders

Accessories for Container Cylinder

Grippers

Buffer Material

Suction

Suction Cups

Suction Stem

Pad in Pad

Air Ejector/Filter/Check Valve

Micro Mold E.O.A.T

Cut

Mini Air Nippers

Air Nippers

Frame/Module

Jungle Gym

Let's Joint

Rectangular Tube

Base Aluminum Material

Sliding Chuck

Tubing/Sensors

Tubing

Sensors

Other Products

Others

Information

Jungle Gym Series Parts

Slide bracket 40 • W • M12

| | |
|----------------|-------------------|
| Order code No. | 131140 |
| Standard | N01863-118 |

● Weight : 10.6g ● M12 fine

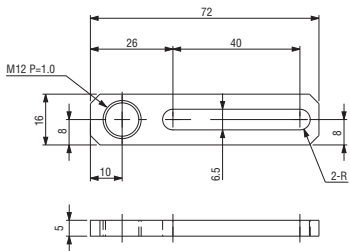

Slide bracket 40 • W • M17

| | |
|----------------|-------------------|
| Order code No. | 131143 |
| Standard | N01863-122 |

● Weight : 21.2g ● M17 fine

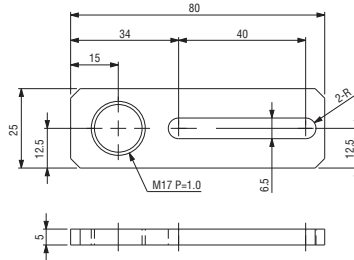

Slide bracket 40 • φ8

| | |
|----------------|-------------------|
| Order code No. | 131152 |
| Standard | N01863-208 |

● Weight : 16.7g

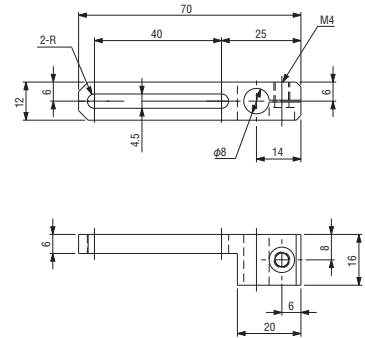

Slide bracket 40 • W • φ8

| | |
|----------------|-------------------|
| Order code No. | 131131 |
| Standard | N01863-106 |

● Weight : 22.7g

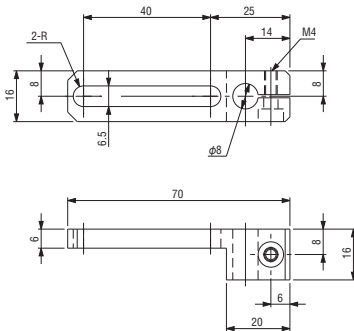

Slide bracket 40 • W • φ12

| | |
|----------------|-------------------|
| Order code No. | 131132 |
| Standard | N01863-107 |

● Weight : 20.0g

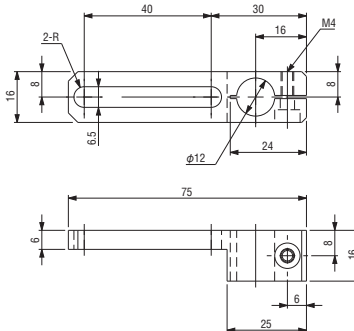

Slide bracket 40 • W • φ20

| | |
|----------------|-------------------|
| Order code No. | 131137 |
| Standard | N01863-114 |

● Weight : 38.9g

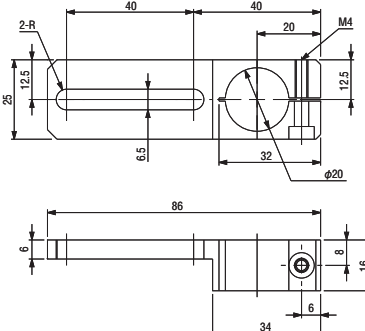

Slide bracket 40 • T • W • φ8

| | |
|----------------|-------------------|
| Order code No. | 230051 |
| Standard | XL0005-102 |

● Weight : 20.7g

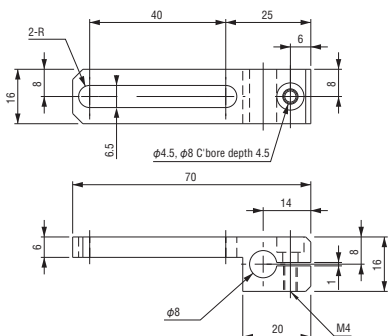

Slide bracket 40 • T • φ8

| | |
|----------------|-------------------|
| Order code No. | 230056 |
| Standard | XL0005-107 |

● Weight : 16.2g

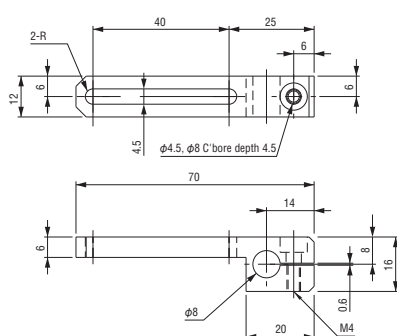

Slide bracket 40 • T • φ12

| | |
|----------------|-------------------|
| Order code No. | 230052 |
| Standard | XL0005-103 |

● Weight : 21.4g

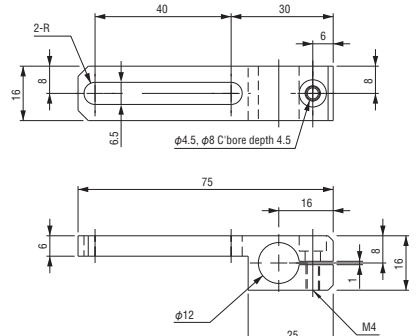

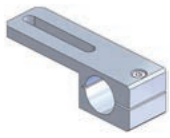

Slide bracket 40 • T • ϕ 20

Order code No. **230054**
Standard **XL0005-105**

● Weight : 54.4g

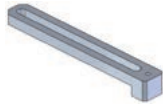
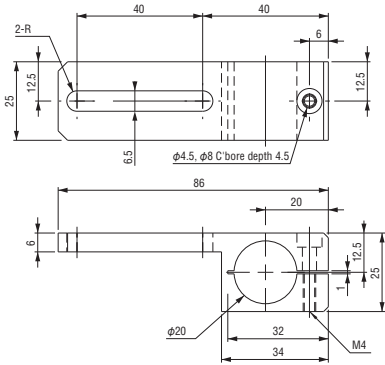

Slide bracket 70 • M3

Order code No. **131159**
Standard **N01863-217**

● Weight : 9.6g

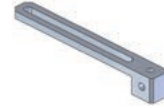
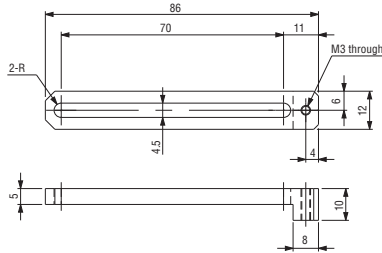

Slide bracket 70 • M5

Order code No. **131148**
Standard **N01863-204**

● Weight : 13.2g

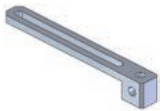
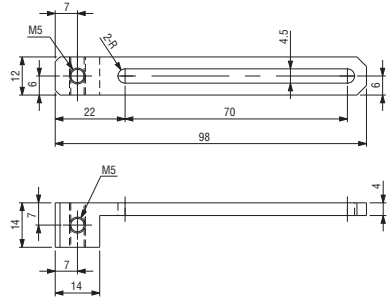

Slide bracket 70 • M6

Order code No. **131157**
Standard **N01863-213**

● Weight : 12.8g ● M6 fine

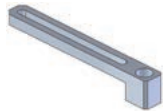
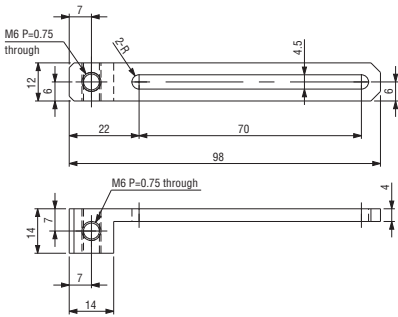

Slide bracket 70 • PT1/8

Order code No. **131155**
Standard **N01863-211**

● Weight : 15.8g

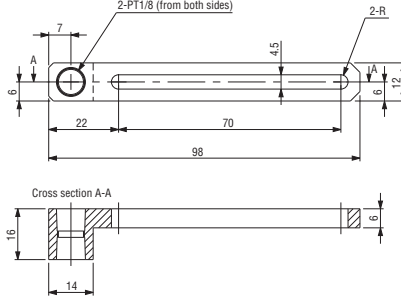

Slide bracket 70 • W • M10

Order code No. **131141**
Standard **N01863-120**

● Weight : 14.5g ● M10 fine

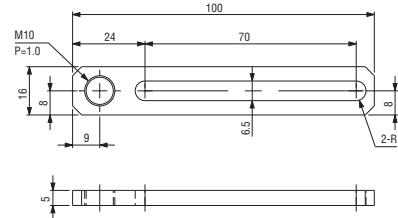

Slide bracket 70 • W • M12

Order code No. **131142**
Standard **N01863-121**

● Weight : 14.6g ● M12 fine

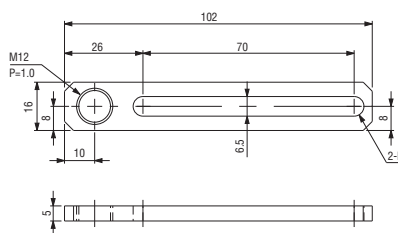

Slide bracket 70 • W • M17

Order code No. **131144**
Standard **N01863-124**

● Weight : 29.0g ● M17 fine

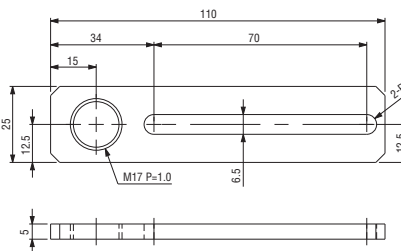

Slide bracket 70 • ϕ 8

Order code No. **131153**
Standard **N01863-209**

● Weight : 20.5g

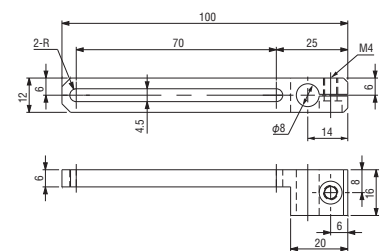

Quick Chuck Change

Quick Chuck Change (Manual)

Tool Changer

Automated Chuck Exchange System

Grip

Mini Cylinder

Accessories for Mini Cylinder

Container Cylinders

Accessories for Container Cylinder

Grippers

Buffer Material

Suction

Suction Cups

Suction Stem

Pad in Pad

Air Ejector/Filter/Check Valve

Micro Mold E.O.A.T

Cut

Mini Air Nippers

Air Nippers

Frame/Module

Jungle Gym

Let's Joint

Rectangular Tube

Base Aluminum Material

Sliding Chuck

Tubing/Sensors

Tubing

Sensors

Other Products

Others

Information

Jungle Gym Series Parts

**Slide bracket 70 •
W • ϕ 8**

| | |
|----------------|-------------------|
| Order code No. | 131133 |
| Standard | N01863-110 |

● Weight : 27.4g

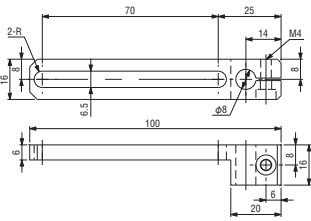

**Slide bracket 70 •
W • ϕ 12**

| | |
|----------------|-------------------|
| Order code No. | 131130 |
| Standard | N01863-103 |

● Weight : 24.7g

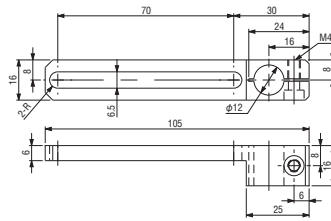

**Slide bracket 70 •
W • ϕ 20**

| | |
|----------------|-------------------|
| Order code No. | 131138 |
| Standard | N01863-115 |

● Weight : 48.3g

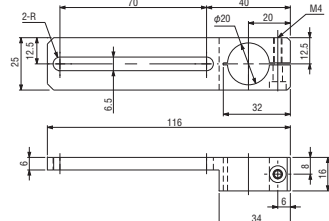

**Slide bracket 70 •
T • W • ϕ 8**

| | |
|----------------|-------------------|
| Order code No. | 230053 |
| Standard | XL0005-104 |

● Weight : 25.4g

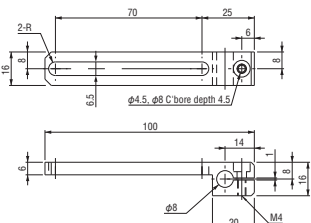

**Slide bracket 70 •
T • ϕ 8**

| | |
|----------------|-------------------|
| Order code No. | 230057 |
| Standard | XL0005-108 |

● Weight : 20.0g

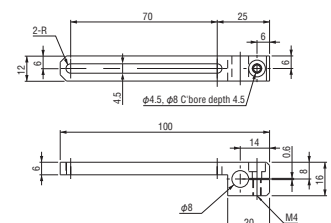

**Slide bracket 70 •
T • ϕ 12**

| | |
|----------------|-------------------|
| Order code No. | 230050 |
| Standard | XL0005-101 |

● Weight : 26.2g

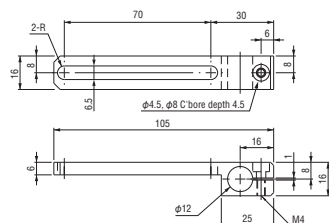

**Slide bracket 70 •
T • ϕ 20**

| | |
|----------------|-------------------|
| Order code No. | 230055 |
| Standard | XL0005-106 |

● Weight : 63.7g

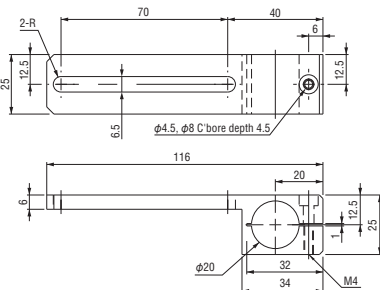

**Slide washer •
 ϕ 8 / ϕ 12**

| | |
|----------------|-------------------|
| Order code No. | 131146 |
| Standard | N01863-202 |

● Weight : 1.0g

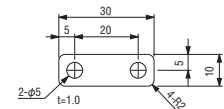

**Slide washer •
W • ϕ 8 / ϕ 12**

| | |
|----------------|-------------------|
| Order code No. | 131129 |
| Standard | N01863-102 |

● Weight : 1.7g

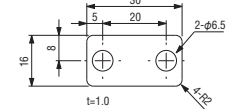

**Slide washer •
 ϕ 20**

| | |
|----------------|-------------------|
| Order code No. | 131150 |
| Standard | N01863-206 |

● Weight : 1.4g

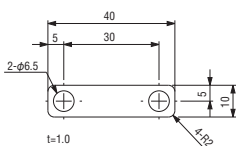

**Slide washer •
W • ϕ 20**

| | |
|----------------|-------------------|
| Order code No. | 131135 |
| Standard | N01863-112 |

● Weight : 2.3g

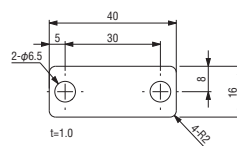

**Nut plate •
for slide bracket**

| | |
|----------------|---------------|
| Order code No. | 023197 |
| Standard | CP-076 |

● Weight : 15.0g

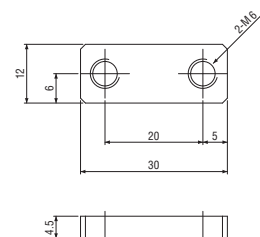

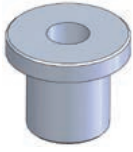

Bushing nut • $\phi 8 \cdot M5$

| | |
|----------------|-------------------|
| Order code No. | 131200 |
| Standard | N01868-401 |

• Weight : 1.4g

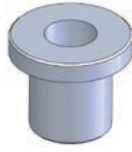
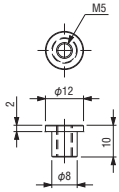

Bushing nut • $\phi 8 \cdot M6$

| | |
|----------------|-------------------|
| Order code No. | 131206 |
| Standard | N01868-410 |

• Weight : 1.3g • M6 fine

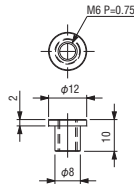

Bushing nut • $\phi 12 \cdot M5$

| | |
|----------------|-------------------|
| Order code No. | 131202 |
| Standard | N01868-403 |

• Weight : 5.5g

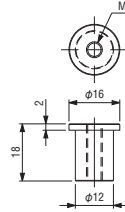

Bushing nut • $\phi 12 \cdot M10$

| | |
|----------------|-------------------|
| Order code No. | 131201 |
| Standard | N01868-402 |

• Weight : 3.0g • M10 fine

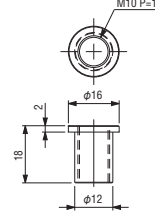

Bushing nut • $\phi 12 \cdot PT1/8$

| | |
|----------------|-------------------|
| Order code No. | 131207 |
| Standard | N01868-411 |

• Weight : 1.7g

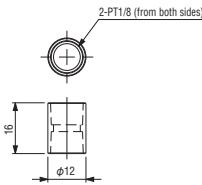

Bushing nut • $\phi 20 \cdot M12$

| | |
|----------------|-------------------|
| Order code No. | 131205 |
| Standard | N01868-409 |

• Weight : 12.3g • M12 fine

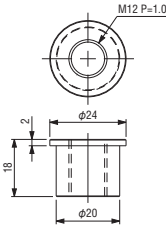

Bushing nut • $\phi 20 \cdot PT1/8$

| | |
|----------------|-------------------|
| Order code No. | 131199 |
| Standard | N01868-305 |

• Weight : 40.0g

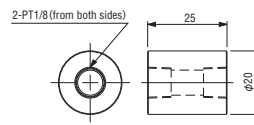

Bushing nut • M5-M3

| | |
|----------------|-------------------|
| Order code No. | 131204 |
| Standard | N01868-407 |

• Weight : 2.6g

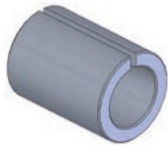
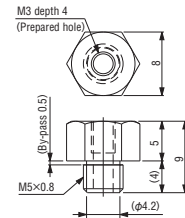

Bushing • $\phi 12 \phi 8$

| | |
|----------------|-------------------|
| Order code No. | 131196 |
| Standard | N01868-301 |

• Weight : 2.8g

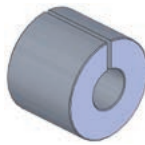
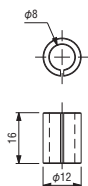

Bushing • $\phi 20 \phi 8$

| | |
|----------------|-------------------|
| Order code No. | 131197 |
| Standard | N01868-302 |

• Weight : 11.6g

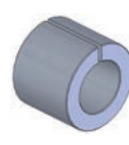
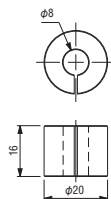

Bushing • $\phi 20 \phi 12$

| | |
|----------------|-------------------|
| Order code No. | 131198 |
| Standard | N01868-303 |

• Weight : 8.9g

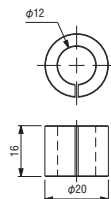

Quick Chuck Change

Quick Chuck Change (Manual)

Tool Changer

Automated Chuck Exchange System

Grip

Mini Cylinder

Accessories for Mini Cylinder

Container Cylinders

Accessories for Container Cylinder

Grippers

Buffer Material

Suction

Suction Cups

Suction Stem

Pad in Pad

Air Ejector/Filter/Check Valve

Micro Mold E.O.A.T

Cut

Mini Air Nippers

Air Nippers

Frame/Module

Jungle Gym

Let's Joint

Rectangular Tube

Base Aluminum Material

Sliding Chuck

Tubing/Sensors

Tubing

Sensors

Other Products

Others

Information

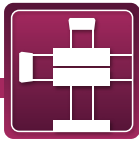

Base Frame Module

Modularized chuck parts for jungle gym.

● Pipe lengths of SS pipes specified in each configuration module and components are different from that of base frame.

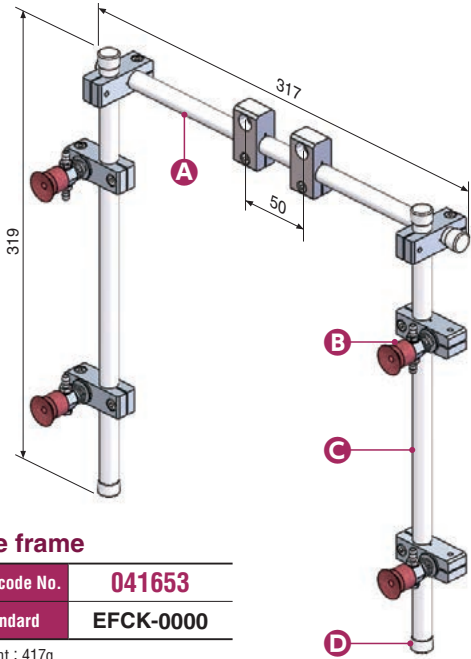

Base frame

| | |
|-----------------|------------------|
| Order code No. | 041653 |
| Standard | EFCK-0000 |
| ● Weight : 417g | |

| Configuration module | Standard | Order code No. | No. of uses | Details |
|------------------------------------------------|--------------------|----------------|-------------|---------|
| A : Base frame for jungle gym | EFCK-0001 | 041654 | 1 | 5-26 |
| B : Suction module for jungle gym (φ12) | JSM-004 | 090158 | 4 | 5-26 |
| C : Jungle gym · SS pipe φ12 | 12*0.6*1000 | 271528 | 1 | 5-8 |
| D : Pipe end cap · φ12 | N01902-002 | 131211 | 4 | 5-9 |

Base frame for jungle gym

components of EFCK-0000...**A**

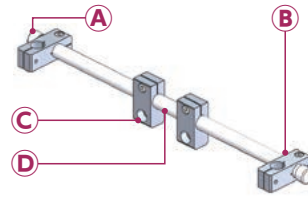

| | |
|-----------------|------------------|
| Order code No. | 041654 |
| Standard | EFCK-0001 |
| ● Weight : 148g | |

| Configuration parts | Standard | Order code No. | No. of uses | Details |
|------------------------------------------|-------------------|----------------|-------------|---------|
| A : Pipe end cap · φ12 | N01902-002 | 131211 | 2 | 5-9 |
| B : Cross connector · φ12φ12 | N01861-202 | 131099 | 2 | 5-10 |
| C : Attachment bracket · φ12 · M6 | N01862-201 | 131118 | 2 | 5-13 |
| D : Jungle gym · SS pipe φ12 | 12*0.6*500 | 271527 | 1 | 5-8 |

Suction module for jungle gym (φ12)

components of EFCK-0000...**B**

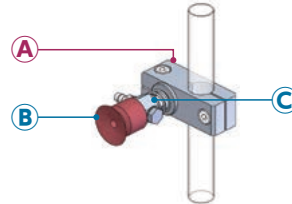

| | |
|----------------|----------------|
| Order code No. | 090158 |
| Standard | JSM-004 |
| ● Weight : 39g | |

| Configuration parts | Standard | Order code No. | No. of uses | Details |
|--------------------------------------------------|----------------------|----------------|-------------|---------|
| A : Cross connector · φ12φ12 | N01861-202 | 131099 | 1 | 5-10 |
| B : Suction cups (standard/silicon/brown) | VAPH-20C | 210194 | 1 | 3-4 |
| C : Suction stem small | VFIL1-S-S-P12 | 211006 | 1 | 3-23 |

Base frame for jungle gym

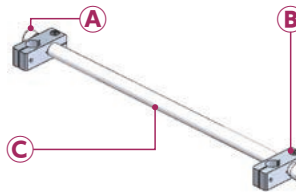

| | |
|----------------|------------------|
| Order code No. | 041655 |
| Standard | EFCK-0002 |
| ● Weight : 96g | |

| Configuration parts | Standard | Order code No. | No. of uses | Details |
|-------------------------------------|-------------------|----------------|-------------|---------|
| A : Pipe end cap · φ12 | N01902-002 | 131211 | 2 | 5-9 |
| B : Cross connector · φ12φ12 | N01861-202 | 131099 | 2 | 5-10 |
| C : Jungle gym · SS pipe φ12 | 12*0.6*500 | 271527 | 1 | 5-8 |

Base frame for jungle gym

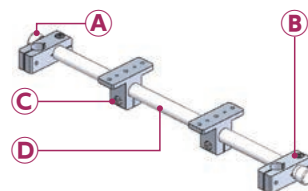

| | |
|-----------------|------------------|
| Order code No. | 041656 |
| Standard | EFCK-0003 |
| ● Weight : 151g | |

| Configuration parts | Standard | Order code No. | No. of uses | Details |
|-----------------------------------------|-------------------|----------------|-------------|---------|
| A : Pipe end cap · φ12 | N01902-002 | 131211 | 2 | 5-9 |
| B : Cross connector · φ12φ12 | N01861-202 | 131099 | 2 | 5-10 |
| C : Bracket · TV · φ12 · for MCD | N01866-401 | 131184 | 2 | 5-18 |
| D : Jungle gym · SS pipe φ12 | 12*0.6*500 | 271527 | 1 | 5-8 |

Base frame for jungle gym

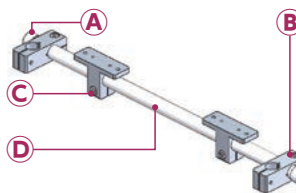

| | |
|-----------------|------------------|
| Order code No. | 041657 |
| Standard | EFCK-0004 |
| ● Weight : 144g | |

| Configuration parts | Standard | Order code No. | No. of uses | Details |
|-----------------------------------------|-------------------|----------------|-------------|---------|
| A : Pipe end cap · φ12 | N01902-002 | 131211 | 2 | 5-9 |
| B : Cross connector · φ12φ12 | N01861-202 | 131099 | 2 | 5-10 |
| C : Bracket · TH · φ12 · for MCD | N01866-301 | 131181 | 2 | 5-17 |
| D : Jungle gym · SS pipe φ12 | 12*0.6*500 | 271527 | 1 | 5-8 |

Base frame for jungle gym

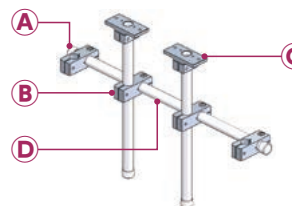

| | |
|-----------------|------------------|
| Order code No. | 041658 |
| Standard | EFCK-0005 |
| ● Weight : 247g | |

| Configuration parts | Standard | Order code No. | No. of uses | Details |
|----------------------------------------|--------------------|----------------|-------------|---------|
| A : Pipe end cap · φ12 | N01902-002 | 131211 | 4 | 5-9 |
| B : Cross connector · φ12φ12 | N01861-202 | 131099 | 4 | 5-10 |
| C : Bracket · T · φ12 · for MCD | N01866-101 | 131176 | 2 | 5-17 |
| D : Jungle gym · SS pipe φ12 | 12*0.6*1000 | 271528 | 1 | 5-8 |

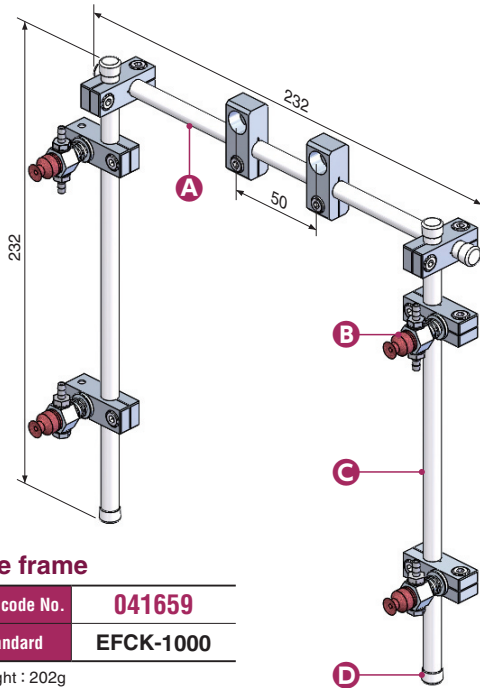

Base frame

| | |
|----------------|------------------|
| Order code No. | 041659 |
| Standard | EFCK-1000 |

● Weight : 202g

| Configuration module | Standard | Order code No. | No. of uses | Details |
|---------------------------------------------|-------------------|----------------|-------------|-------------|
| A Base frame for jungle gym | EFCK-1001 | 041660 | 1 | 5-27 |
| B Suction module for jungle gym (φ8) | JSM-001 | 090155 | 4 | 5-27 |
| C Jungle gym SS pipe φ8 | 8*0.6*500 | 340905 | 1 | 5-8 |
| D Pipe end cap φ8 | N01902-003 | 131212 | 4 | 5-9 |

Base frame for jungle gym

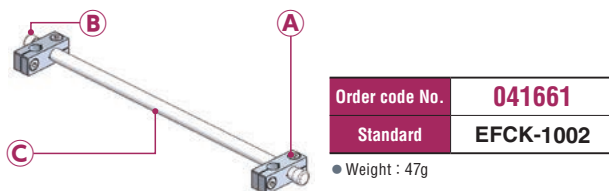

| | |
|----------------|------------------|
| Order code No. | 041661 |
| Standard | EFCK-1002 |

● Weight : 47g

| Configuration parts | Standard | Order code No. | No. of uses | Details |
|--------------------------------|-------------------|----------------|-------------|-------------|
| A Cross connector φ8φ8 | N01861-207 | 131102 | 2 | 5-10 |
| B Pipe end cap φ8 | N01902-003 | 131212 | 2 | 5-9 |
| C Jungle gym SS pipe φ8 | 8*0.6*500 | 340905 | 1 | 5-8 |

Base frame for jungle gym

components of EFCK-1000...**A**

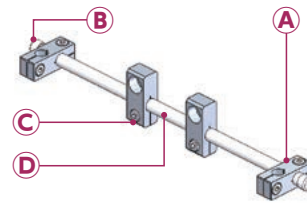

| | |
|----------------|------------------|
| Order code No. | 041660 |
| Standard | EFCK-1001 |

● Weight : 72g

| Configuration parts | Standard | Order code No. | No. of uses | Details |
|-----------------------------------|-------------------|----------------|-------------|-------------|
| A Cross connector φ8φ8 | N01861-207 | 131102 | 2 | 5-10 |
| B Pipe end cap φ8 | N01902-003 | 131212 | 2 | 5-9 |
| C Attachment bracket φ8 M6 | N01862-205 | 131121 | 2 | 5-13 |
| D Jungle gym SS pipe φ8 | 8*0.6*500 | 340905 | 1 | 5-8 |

Suction module for jungle gym (φ8)

components of EFCK-1000...**B**

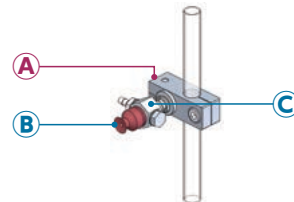

| | |
|----------------|----------------|
| Order code No. | 090155 |
| Standard | JSM-001 |

● Weight : 21g

| Configuration parts | Standard | Order code No. | No. of uses | Details |
|------------------------------------------------|---------------------|----------------|-------------|-------------|
| A Cross connector φ8φ8 | N01861-207 | 131102 | 1 | 5-10 |
| B Suction cups (standard/silicon/brown) | VAPH-8C | 210191 | 1 | 3-4 |
| C Suction stem mini | VFL2-SS-5-P8 | 211030 | 1 | 3-21 |

Base frame for jungle gym

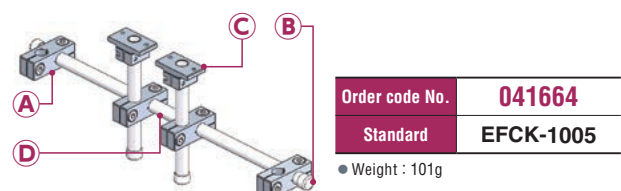

| | |
|----------------|------------------|
| Order code No. | 041664 |
| Standard | EFCK-1005 |

● Weight : 101g

| Configuration parts | Standard | Order code No. | No. of uses | Details |
|---------------------------------|-------------------|----------------|-------------|-------------|
| A Cross connector φ8φ8 | N01861-207 | 131102 | 4 | 5-10 |
| B Pipe end cap φ8 | N01902-003 | 131212 | 4 | 5-9 |
| C Bracket TH φ8 for UMCD | N01866-102 | 131177 | 2 | 5-17 |
| D Jungle gym SS pipe φ8 | 8*0.6*500 | 340905 | 1 | 5-8 |

▶ **Discontinued product** (Following module product is created by combination of components.)

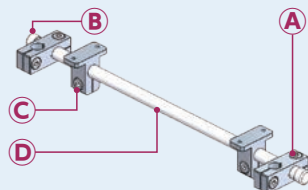

Base frame for jungle gym

| Configuration parts | Standard | Order code No. | No. of uses | Details |
|---------------------------------|-------------------|----------------|-------------|-------------|
| A Cross connector φ8φ8 | N01861-207 | 131102 | 2 | 5-10 |
| B Pipe end cap φ8 | N01902-003 | 131212 | 2 | 5-9 |
| C Bracket TV φ8 for UMCD | N01866-402 | 131185 | 2 | 5-18 |
| D Jungle gym SS pipe φ8 | 8*0.6*500 | 340905 | 1 | 5-8 |

* Pipe length is 500mm if only SS pipe φ8 is ordered.

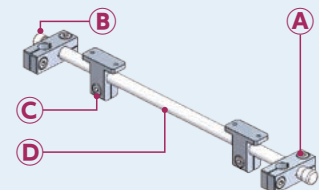

Base frame for jungle gym

| Configuration parts | Standard | Order code No. | No. of uses | Details |
|---------------------------------|-------------------|----------------|-------------|-------------|
| A Cross connector φ8φ8 | N01861-207 | 131102 | 2 | 5-10 |
| B Pipe end cap φ8 | N01902-003 | 131212 | 2 | 5-9 |
| C Bracket TH φ8 for UMCD | N01866-302 | 131182 | 2 | 5-17 |
| D Jungle gym SS pipe φ8 | 8*0.6*500 | 340905 | 1 | 5-8 |

* Pipe length is 500mm if only SS pipe φ8 is ordered.

Quick Chuck Change

| |
|---------------------------------|
| Quick Chuck Change (Manual) |
| Tool Changer |
| Automated Chuck Exchange System |

Grip

| |
|------------------------------------|
| Mini Cylinder |
| Accessories for Mini Cylinder |
| Container Cylinders |
| Accessories for Container Cylinder |

Grippers

| |
|-----------------|
| Buffer Material |
|-----------------|

Suction

| |
|--------------------------------|
| Suction Cups |
| Suction Stem |
| Pad in Pad |
| Air Ejector/Filter/Check Valve |
| Micro Mold E.O.A.T |

Cut

| |
|------------------|
| Mini Air Nippers |
| Air Nippers |

Frame/Module

| |
|-------------|
| Jungle Gym |
| Let's Joint |

| |
|------------------------|
| Rectangular Tube |
| Base Aluminum Material |

Sliding Chuck

Tubing/Sensors

| |
|---------|
| Tubing |
| Sensors |

Other Products

| |
|--------|
| Others |
|--------|

Information

Base Frame Module

● Pipe lengths of SS pipes specified in each configuration module and components are different from that of base frame.

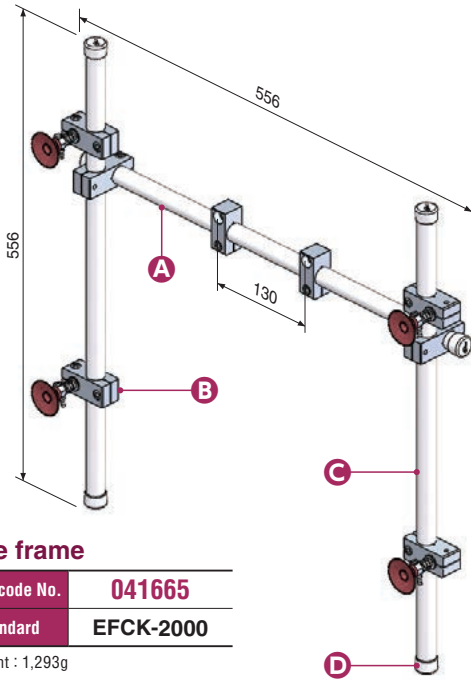

Base frame

| | |
|-------------------|------------------|
| Order code No. | 041665 |
| Standard | EFCK-2000 |
| ● Weight : 1,293g | |

| Configuration module | Standard | Order code No. | No. of uses | Details |
|------------------------------------------------|--------------------|----------------|-------------|---------|
| A : Base frame for jungle gym | EFCK-2001 | 041666 | 1 | 5-28 |
| B : Suction module for jungle gym (φ20) | JSM-008 | 090162 | 4 | 5-28 |
| C : Jungle gym · SS pipe φ20 | 20*0.8*1500 | 281814 | 1 | 5-8 |
| D : Pipe end cap · φ20 | N01902-001 | 131210 | 4 | 5-9 |

Base frame for jungle gym

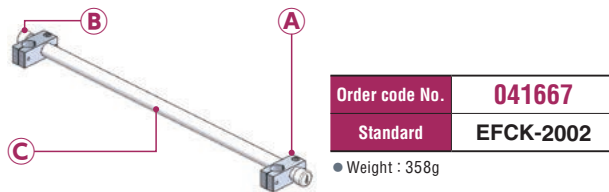

| | |
|-----------------|------------------|
| Order code No. | 041667 |
| Standard | EFCK-2002 |
| ● Weight : 358g | |

| Configuration parts | Standard | Order code No. | No. of uses | Details |
|--------------------------------------|--------------------|----------------|-------------|---------|
| A : Cross connector · φ20 φ20 | N01861-206 | 131101 | 2 | 5-10 |
| B : Pipe end cap · φ20 | N01902-001 | 131210 | 2 | 5-9 |
| C : Jungle gym · SS pipe φ20 | 20*0.8*1000 | 281813 | 1 | 5-8 |

Base frame for jungle gym

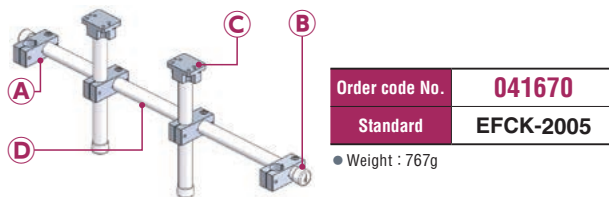

| | |
|-----------------|------------------|
| Order code No. | 041670 |
| Standard | EFCK-2005 |
| ● Weight : 767g | |

| Configuration parts | Standard | Order code No. | No. of uses | Details |
|----------------------------------------|--------------------|----------------|-------------|---------|
| A : Cross connector · φ20 φ20 | N01861-206 | 131101 | 4 | 5-10 |
| B : Pipe end cap · φ20 | N01902-001 | 131210 | 4 | 5-9 |
| C : Bracket · T · φ20 · for MCD | N01866-103A | 131554 | 2 | 5-17 |
| D : Jungle gym · SS pipe φ20 | 20*0.8*1000 | 281813 | 1 | 5-8 |

Base frame for jungle gym components of EFCK-2000...**A**

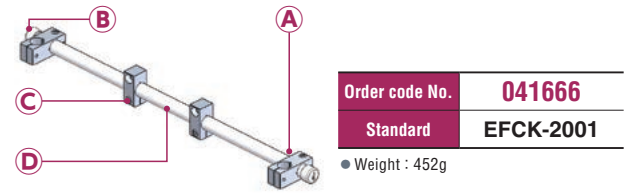

| | |
|-----------------|------------------|
| Order code No. | 041666 |
| Standard | EFCK-2001 |
| ● Weight : 452g | |

| Configuration parts | Standard | Order code No. | No. of uses | Details |
|------------------------------------------|--------------------|----------------|-------------|---------|
| A : Cross connector · φ20 φ20 | N01861-206 | 131101 | 2 | 5-10 |
| B : Pipe end cap · φ20 | N01902-001 | 131210 | 2 | 5-9 |
| C : Attachment bracket · φ20 · M8 | N01862-214 | 131226 | 2 | 5-13 |
| D : Jungle gym · SS pipe φ20 | 20*0.8*1000 | 281813 | 1 | 5-8 |

Suction module for jungle gym (φ20) components of EFCK-2000...**B**

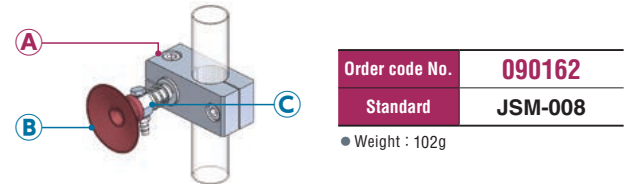

| | |
|-----------------|----------------|
| Order code No. | 090162 |
| Standard | JSM-008 |
| ● Weight : 102g | |

| Configuration parts | Standard | Order code No. | No. of uses | Details |
|--------------------------------------------------|----------------------|----------------|-------------|---------|
| A : Cross connector · φ20 φ12 | N01861-204 | 131100 | 1 | 5-10 |
| B : Suction cups (standard/silicon/brown) | VAPH-40C | 210196 | 1 | 3-5 |
| C : Suction stem small | VFIL1-S-5-P12 | 211006 | 1 | 3-23 |

Base frame for jungle gym

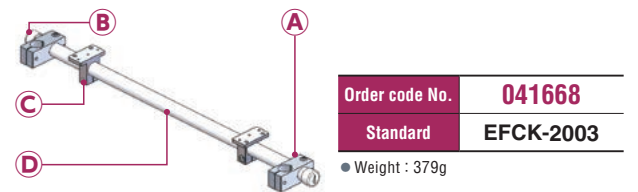

| | |
|-----------------|------------------|
| Order code No. | 041668 |
| Standard | EFCK-2003 |
| ● Weight : 379g | |

| Configuration parts | Standard | Order code No. | No. of uses | Details |
|-----------------------------------------|--------------------|----------------|-------------|---------|
| A : Cross connector · φ20 φ20 | N01861-206 | 131101 | 2 | 5-10 |
| B : Pipe end cap · φ20 | N01902-001 | 131210 | 2 | 5-9 |
| C : Bracket · TV · φ20 · for MCD | N01866-403 | 131186 | 2 | 5-18 |
| D : Jungle gym · SS pipe φ20 | 20*0.8*1000 | 281813 | 1 | 5-8 |

Discontinued product

(Following module product is created by combination of components.)

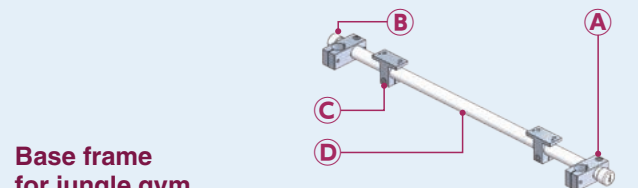

Base frame for jungle gym

| Configuration parts | Standard | Order code No. | No. of uses | Details |
|-----------------------------------------|--------------------|----------------|-------------|---------|
| A : Cross connector · φ20 φ20 | N01861-206 | 131101 | 2 | 5-10 |
| B : Pipe end cap · φ20 | N01902-001 | 131210 | 2 | 5-9 |
| C : Bracket · TH · φ20 · for MCD | N01866-303 | 131183 | 2 | 5-18 |
| D : Jungle gym · SS pipe φ20 | 20*0.8*1000 | 281813 | 1 | 5-8 |

* Pipe length is 1000mm if only SS pipe φ20 is ordered.

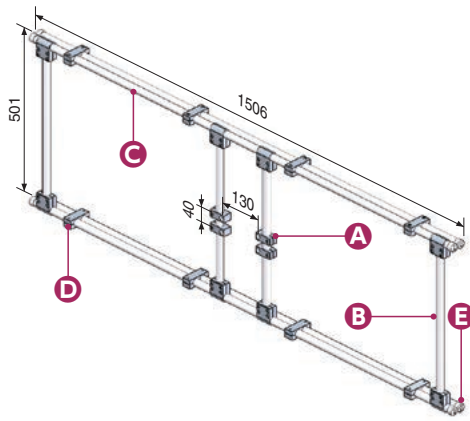

Base frame

| | |
|----------------|------------------|
| Order code No. | 041671 |
| Standard | EFCK-2500 |

● Weight : 4,282g

| Configuration module | Standard | Order code No. | No. of uses | Details |
|-------------------------------------------------|-------------|----------------|-------------|-------------|
| A Base frame for jungle gym | EFCK-2501 | 041672 | 2 | 5-29 |
| B Base frame for jungle gym | EFCK-2502 | 041673 | 2 | 5-29 |
| C Jungle gym · SS pipe $\phi 20$ | 20*0.8*1500 | 281814 | 4 | 5-8 |
| D Parallel connector · $\phi 20 \phi 20$ | N01861-106 | 131095 | 8 | 5-12 |
| E Pipe end cap · $\phi 20$ | N01902-001 | 131210 | 8 | 5-9 |

Base frame for jungle gym components of EFCK-2500...**A**

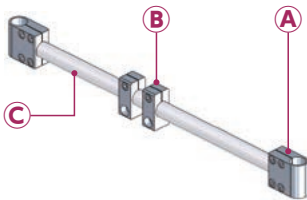

| | |
|----------------|------------------|
| Order code No. | 041672 |
| Standard | EFCK-2501 |

● Weight : 457g

| Configuration parts | Standard | Order code No. | No. of uses | Details |
|--------------------------------------------------|------------|----------------|-------------|-------------|
| A T Connector #2 · $\phi 20 \phi 20$ | N01861-405 | 131114 | 2 | 5-12 |
| B Attachment bracket · $\phi 20 \cdot M8$ | N01862-214 | 131226 | 2 | 5-13 |
| C Jungle gym · SS pipe $\phi 20$ | 20*0.8*500 | 281812 | 1 | 5-8 |

Base frame for jungle gym components of EFCK-2500...**B**

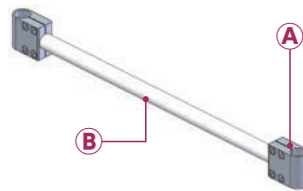

| | |
|----------------|------------------|
| Order code No. | 041673 |
| Standard | EFCK-2502 |

● Weight : 363g

| Configuration parts | Standard | Order code No. | No. of uses | Details |
|---------------------------------------------|------------|----------------|-------------|-------------|
| A T Connector #2 · $\phi 20 \phi 20$ | N01861-405 | 131114 | 2 | 5-12 |
| B Jungle gym · SS pipe $\phi 20$ | 20*0.8*500 | 281812 | 1 | 5-8 |

Discontinued product (Following module product is created by combination of components.)

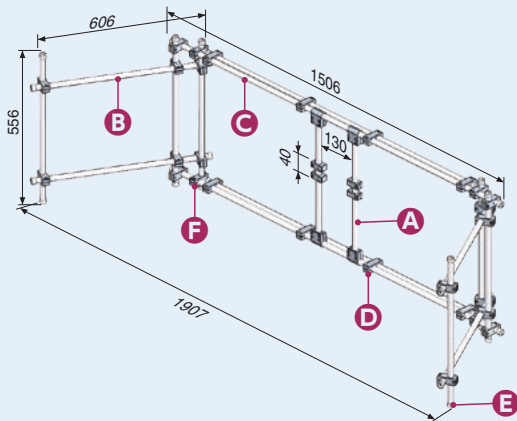

Base frame

| Configuration module | Standard | Order code No. | No. of uses | Details |
|-------------------------------------------------|-------------|----------------|-------------|-------------|
| A Base frame for jungle gym | EFCK-2501 | 041672 | 2 | 5-29 |
| B Base frame for jungle gym | EFCK-2602 | 041676 | 6 | — |
| C Jungle gym · SS pipe $\phi 20$ | 20*0.8*1500 | 281814 | 4 | 5-8 |
| D Parallel connector · $\phi 20 \phi 20$ | N01861-106 | 131095 | 8 | 5-12 |
| E Pipe end cap · $\phi 20$ | N01902-001 | 131210 | 8 | 5-9 |
| F Cross connector · $\phi 20 \phi 20$ | N01861-206 | 131101 | 8 | 5-10 |

* Pipe length is 1500mm if only SS pipe $\phi 20$ is ordered.

Base frame for jungle gym components of EFCK-2600...**A**

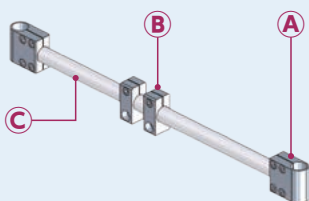

| Configuration parts | Standard | Order code No. | No. of uses | Details |
|--------------------------------------------------|------------|----------------|-------------|-------------|
| A T Connector #2 · $\phi 20 \phi 20$ | N01861-405 | 131114 | 2 | 5-12 |
| B Attachment bracket · $\phi 20 \cdot M8$ | N01862-214 | 131226 | 2 | 5-13 |
| C Jungle gym · SS pipe $\phi 20$ | 20*0.8*500 | 281812 | 1 | 5-8 |

* Pipe length is 500mm if only SS pipe $\phi 20$ is ordered.

Base frame for jungle gym components of EFCK-2600...**B**

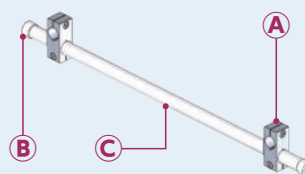

| Configuration parts | Standard | Order code No. | No. of uses | Details |
|----------------------------------------------|------------|----------------|-------------|-------------|
| A Cross connector · $\phi 20 \phi 20$ | N01861-206 | 131101 | 2 | 5-10 |
| B Pipe end cap · $\phi 20$ | N01902-001 | 131210 | 2 | 5-9 |
| C Jungle gym · SS pipe $\phi 20$ | 20*0.8*500 | 281812 | 1 | 5-8 |

* Pipe length is 500mm if only SS pipe $\phi 20$ is ordered.

Quick Chuck Change

Quick Chuck Change (Manual)

Tool Changer

Automated Chuck Exchange System

Grip

Mini Cylinder

Accessories for Mini Cylinder

Container Cylinders

Accessories for Container Cylinder

Grippers

Buffer Material

Suction

Suction Cups

Suction Stem

Pad in Pad

Air Ejector/Filter/Check Valve

Micro Mold E.O.A.T

Cut

Mini Air Nippers

Air Nippers

Frame/Module

Jungle Gym

Let's Joint

Rectangular Tube

Base Aluminum Material

Sliding Chuck

Tubing/Sensors

Tubing

Sensors

Other Products

Others

Information

Information

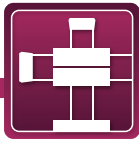

Suction Module

Modularized chuck parts for jungle gym.

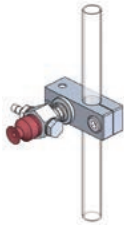

Suction module for jungle gym (φ8)

| | |
|----------------|----------------|
| Order code No. | 090155 |
| Standard | JSM-001 |

● Weight : 21g ● Suction stem : VFIL2-SS-5-P8

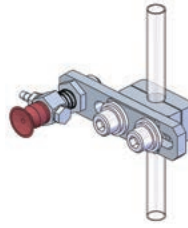

Suction module for jungle gym (φ8)

| | |
|----------------|----------------|
| Order code No. | 090156 |
| Standard | JSM-002 |

● Weight : 57g ● Suction stem : VFIL1-SS-5

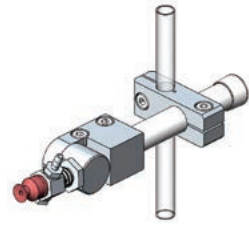

Suction module for jungle gym (φ8)

| | |
|----------------|----------------|
| Order code No. | 090157 |
| Standard | JSM-003 |

● Weight : 81g ● Suction stem : VFIL1-SS-5

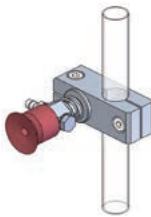

Suction module for jungle gym (φ12)

| | |
|----------------|----------------|
| Order code No. | 090158 |
| Standard | JSM-004 |

● Weight : 39g ● Suction stem : VFIL1-S-5-P12

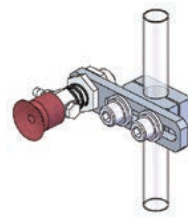

Suction module for jungle gym (φ12)

| | |
|----------------|----------------|
| Order code No. | 090159 |
| Standard | JSM-005 |

● Weight : 69g ● Suction stem : VFIL-S-5A

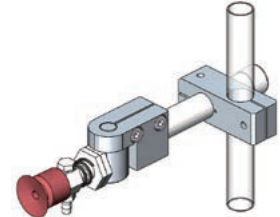

Suction module for jungle gym (φ12)

| | |
|----------------|----------------|
| Order code No. | 090160 |
| Standard | JSM-006 |

● Weight : 92g ● Suction stem : VFIL-S-5A

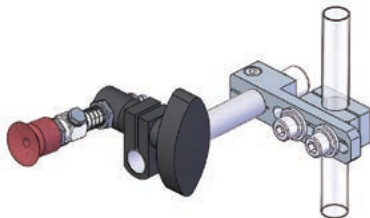

Suction module for jungle gym (φ12)

| | |
|----------------|----------------|
| Order code No. | 090161 |
| Standard | JSM-007 |

● Weight : 151g ● Suction stem : VFILB2-SH

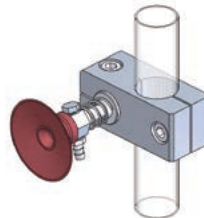

Suction module for jungle gym (φ20)

| | |
|----------------|----------------|
| Order code No. | 090162 |
| Standard | JSM-008 |

● Weight : 102g ● Suction stem : VFIL1-S-5-P12

Example of using suction module

JSM-005 (090159)

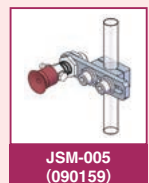
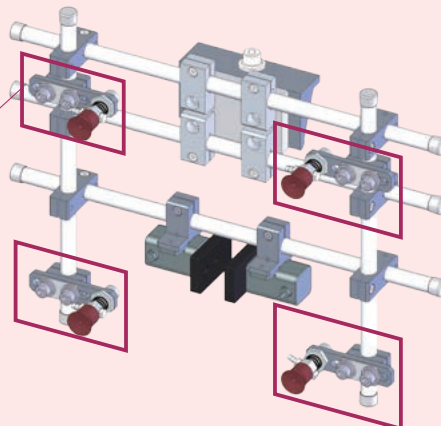

JSM-005
(090159)

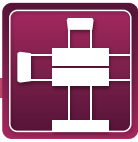

Gripper Module

Modularized chuck parts for jungle gym.

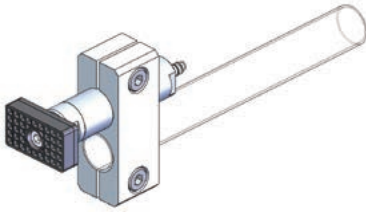

Gripper module • for jungle gym (φ 12)

| | |
|----------------|----------------|
| Order code No. | 090163 |
| Standard | JGM-001 |

● Weight : 41g ● Cylinder for pipe attachment : MCP-1210

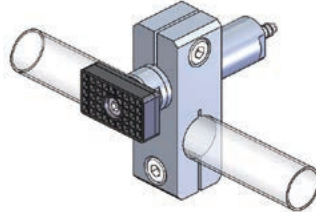

Gripper module • for jungle gym (φ 12)

| | |
|----------------|----------------|
| Order code No. | 090164 |
| Standard | JGM-002 |

● Weight : 43g ● Cylinder for pipe attachment : MCP-1210

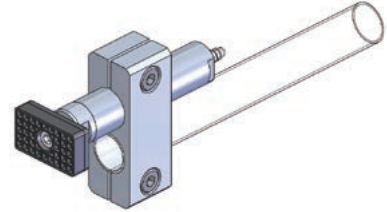

Gripper module • for jungle gym (φ 12)

| | |
|----------------|----------------|
| Order code No. | 090165 |
| Standard | JGM-003 |

● Weight : 42g ● Cylinder for pipe attachment : MCP-1220

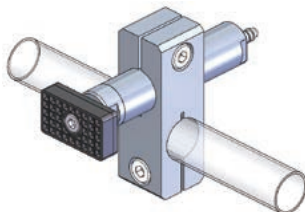

Gripper module • for jungle gym (φ 12)

| | |
|----------------|----------------|
| Order code No. | 090166 |
| Standard | JGM-004 |

● Weight : 44g ● Cylinder for pipe attachment : MCP-1220

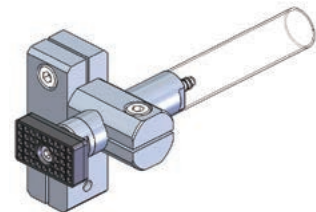

Gripper module • for jungle gym (φ 12)

| | |
|----------------|----------------|
| Order code No. | 090167 |
| Standard | JGM-005 |

● Weight : 58g ● Cylinder for pipe attachment : MCP-1210

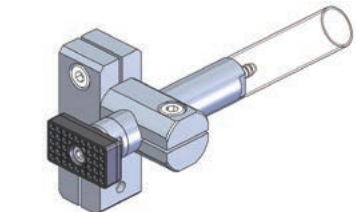

Gripper module • for jungle gym (φ 12)

| | |
|----------------|----------------|
| Order code No. | 090168 |
| Standard | JGM-006 |

● Weight : 59g ● Cylinder for pipe attachment : MCP-1220

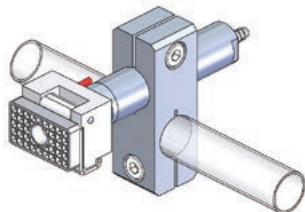

Gripper module • for jungle gym (φ 12)

| | |
|----------------|----------------|
| Order code No. | 090169 |
| Standard | JGM-007 |

● Weight : 62g ● Cylinder for pipe attachment : MCP-1220

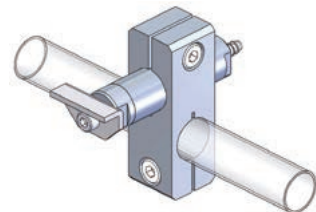

Gripper module • for jungle gym (φ 12)

| | |
|----------------|----------------|
| Order code No. | 090171 |
| Standard | JGM-009 |

● Weight : 41g ● Cylinder for pipe attachment : MCP-1210

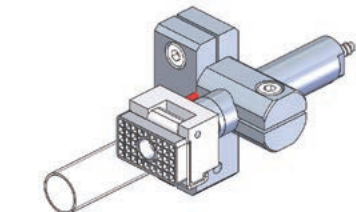

Gripper module • for jungle gym (φ 12)

| | |
|----------------|----------------|
| Order code No. | 090173 |
| Standard | JGM-011 |

● Weight : 77g ● Cylinder for pipe attachment : MCP-1220

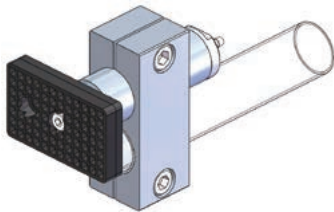

Gripper module • for jungle gym (φ 20)

| | |
|----------------|----------------|
| Order code No. | 090174 |
| Standard | JGM-012 |

● Weight : 157g ● Cylinder for pipe attachment : MCP-2010

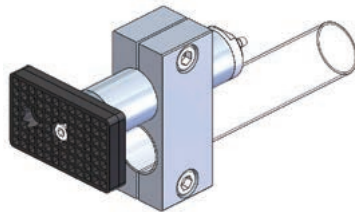

Gripper module • for jungle gym (φ 20)

| | |
|----------------|----------------|
| Order code No. | 090175 |
| Standard | JGM-013 |

● Weight : 161g ● Cylinder for pipe attachment : MCP-2020

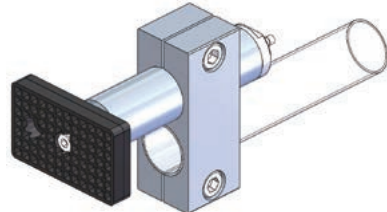

Gripper module • for jungle gym (φ 20)

| | |
|----------------|----------------|
| Order code No. | 090176 |
| Standard | JGM-014 |

● Weight : 167g ● Cylinder for pipe attachment : MCP-2030

Quick Chuck Change

Quick Chuck Change (Manual)

Tool Changer

Automated Chuck Exchange System

Grip

Mini Cylinder

Accessories for Mini Cylinder

Container Cylinders

Accessories for Container Cylinder

Grippers

Buffer Material

Suction

Suction Cups

Suction Stem

Pad in Pad

Air Ejector/Filter/Check Valve

Micro Mold E.O.A.T

Cut

Mini Air Nippers

Air Nippers

Frame/Module

Jungle Gym

Let's Joint

Rectangular Tube

Base Aluminum Material

Sliding Chuck

Tubing/Sensors

Tubing

Sensors

Other Products

Others

Information

Gripper Module

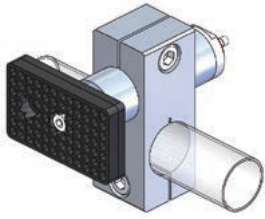

Gripper module • for jungle gym (ϕ 20)

| | |
|----------------|----------------|
| Order code No. | 090178 |
| Standard | JGM-016 |

● Weight : 156g ● Cylinder for pipe attachment : MCP-2010

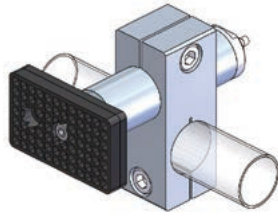

Gripper module • for jungle gym (ϕ 20)

| | |
|----------------|----------------|
| Order code No. | 090179 |
| Standard | JGM-017 |

● Weight : 160g ● Cylinder for pipe attachment : MCP-2020

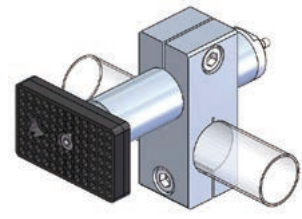

Gripper module • for jungle gym (ϕ 20)

| | |
|----------------|----------------|
| Order code No. | 090180 |
| Standard | JGM-018 |

● Weight : 166g ● Cylinder for pipe attachment : MCP-2030

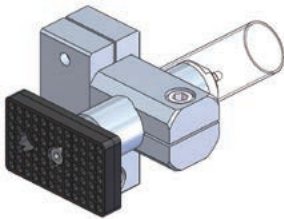

Gripper module • for jungle gym (ϕ 20)

| | |
|----------------|----------------|
| Order code No. | 090182 |
| Standard | JGM-020 |

● Weight : 212g ● Cylinder for pipe attachment : MCP-2010

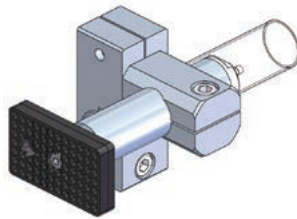

Gripper module • for jungle gym (ϕ 20)

| | |
|----------------|----------------|
| Order code No. | 090184 |
| Standard | JGM-022 |

● Weight : 222g ● Cylinder for pipe attachment : MCP-2030

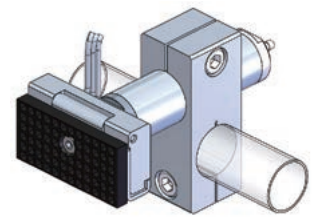

Gripper module • for jungle gym (ϕ 20)

| | |
|----------------|----------------|
| Order code No. | 090185 |
| Standard | JGM-023 |

● Weight : 176g ● Cylinder for pipe attachment : MCP-2020

Example of using gripper module

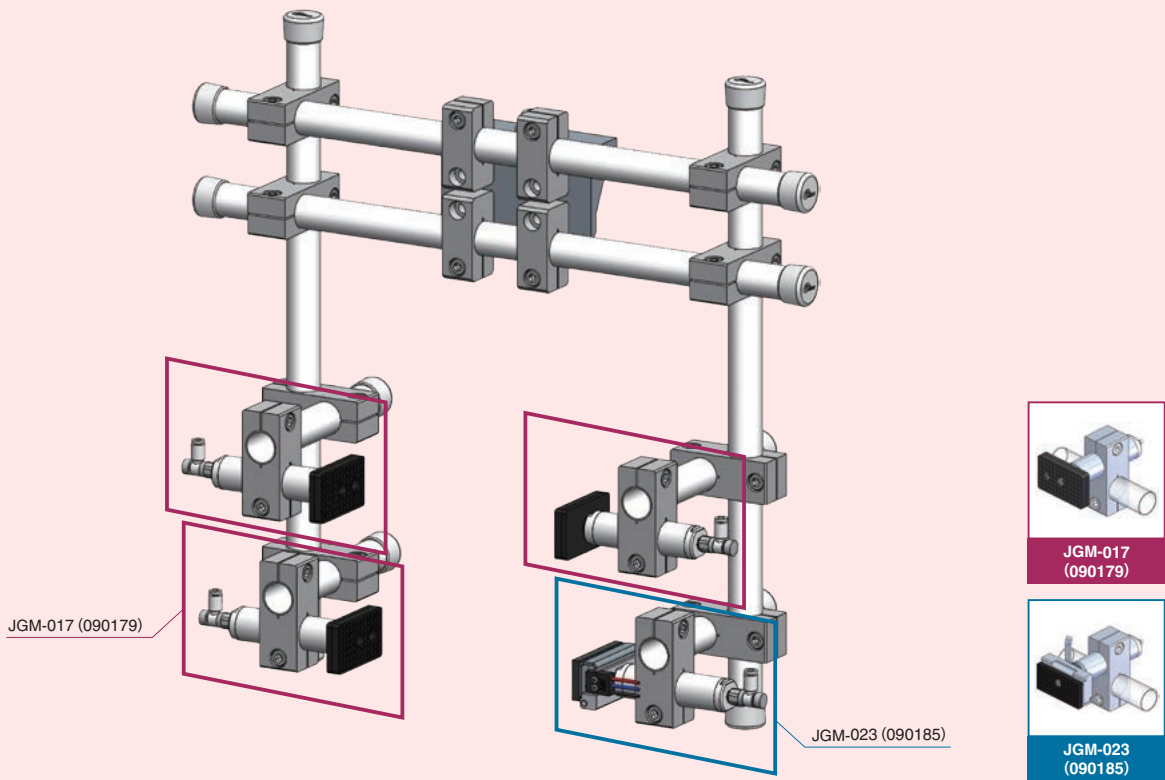

▶ **Discontinued product** (Following module product is created by combination of components.)

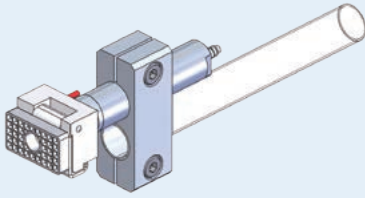

Gripper module • for jungle gym (φ 12)

| Configuration parts | Standard | Order code No. |
|--------------------------------------------|-------------|----------------|
| Pad rectangle w/SW for micro-mini cylinder | L1131-100-0 | 110568 |
| Cylinder for pipe attachment | MCP-1220 | 122825 |
| Parallel connector • φ 12 φ 12 | N01861-102 | 131093 |

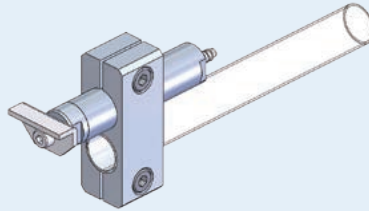

Gripper module • for jungle gym (φ 12)

| Configuration parts | Standard | Order code No. |
|--------------------------------------|------------|----------------|
| Claw L shape for micro mini cylinder | CPUM-02 | 022798 |
| Cylinder for pipe attachment | MCP-1220 | 122825 |
| Parallel connector • φ 12 φ 12 | N01861-102 | 131093 |

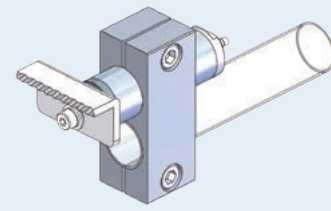

Gripper module • for jungle gym (φ 20)

| Configuration parts | Standard | Order code No. |
|--------------------------------|------------|----------------|
| Claw L shape for mini cylinder | CP-014 | 370073 |
| Cylinder for pipe attachment | MCP-2010 | 122826 |
| Parallel connector • φ 20 φ 20 | N01861-106 | 131095 |

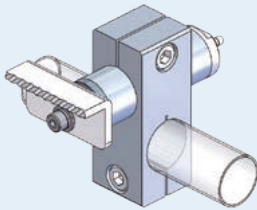

Gripper module • for jungle gym (φ 20)

| Configuration parts | Standard | Order code No. |
|--------------------------------|------------|----------------|
| Claw L shape for mini cylinder | CP-014 | 370073 |
| Cylinder for pipe attachment | MCP-2010 | 122826 |
| Cross connector • φ 20 φ 20 | N01861-206 | 131101 |

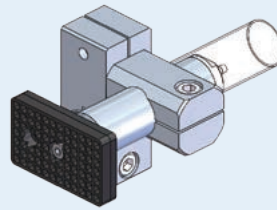

Gripper module • for jungle gym (φ 20)

| Configuration parts | Standard | Order code No. |
|-----------------------------------------------|------------|----------------|
| Pad rectangle black 2 holes for mini cylinder | CP-060 | 370835 |
| Cylinder for pipe attachment | MCP-2020 | 122827 |
| Rotation bracket • φ 20 • 20A | N01864-304 | 131171 |
| Cross connector • φ 20 φ 20 | N01861-206 | 131101 |

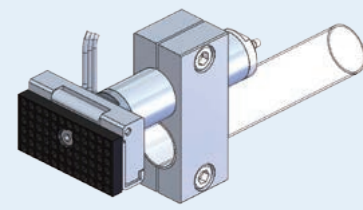

Gripper module • for jungle gym (φ 20)

| Configuration parts | Standard | Order code No. |
|--------------------------------------------|------------|----------------|
| Pad rectangle w/black SW for mini cylinder | KRC1-5000 | 101714 |
| Cylinder for pipe attachment | MCP-2020 | 122827 |
| Parallel connector • φ 20 φ 20 | N01861-106 | 131095 |

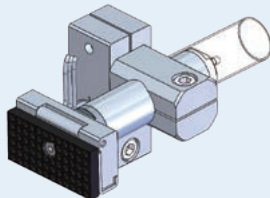

Gripper module • for jungle gym (φ 20)

| Configuration parts | Standard | Order code No. |
|--------------------------------------------|------------|----------------|
| Pad rectangle w/black SW for mini cylinder | KRC1-5000 | 101714 |
| Cylinder for pipe attachment | MCP-2020 | 122827 |
| Rotation bracket • φ 20 • 20A | N01864-304 | 131171 |
| Cross connector • φ 20 φ 20 | N01861-206 | 131101 |

Quick Chuck Change

Quick Chuck Change (Manual)

Tool Changer

Automated Chuck Exchange System

Grip

Mini Cylinder

Accessories for Mini Cylinder

Container Cylinders

Accessories for Container Cylinder

Grippers

Buffer Material

Suction

Suction Cups

Suction Stem

Pad in Pad

Air Ejector/Filter/Check Valve

Micro Mold E.O.A.T

Cut

Mini Air Nippers

Air Nippers

Frame/Module

Jungle Gym

Let's Joint

Rectangular Tube

Base Aluminum Material

Sliding Chuck

Tubing/Sensors

Tubing

Sensors

Other Products

Others

Information

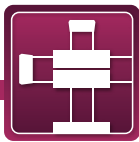

Limit Switch Module

Modularized chuck parts for jungle gym.

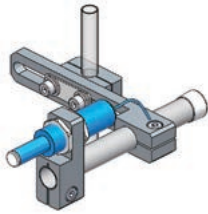

Limit switch module • for jungle gym (φ8)

| | |
|----------------|----------------|
| Order code No. | 090188 |
| Standard | JLM-001 |

● Weight : 91g

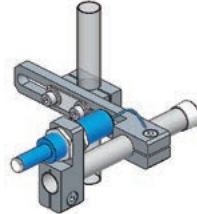

Limit switch module • for jungle gym (φ12)

| | |
|----------------|----------------|
| Order code No. | 090189 |
| Standard | JLM-002 |

● Weight : 89g

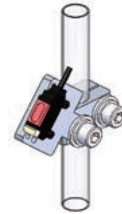

Limit switch module • for jungle gym (φ12)

| | |
|----------------|----------------|
| Order code No. | 090190 |
| Standard | JLM-003 |

● Weight : 64g

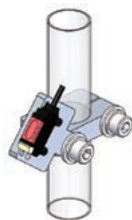

Limit switch module • for jungle gym (φ20)

| | |
|----------------|----------------|
| Order code No. | 090191 |
| Standard | JLM-004 |

● Weight : 69g

Example of using limit switch module

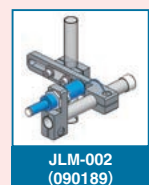
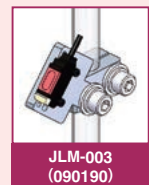
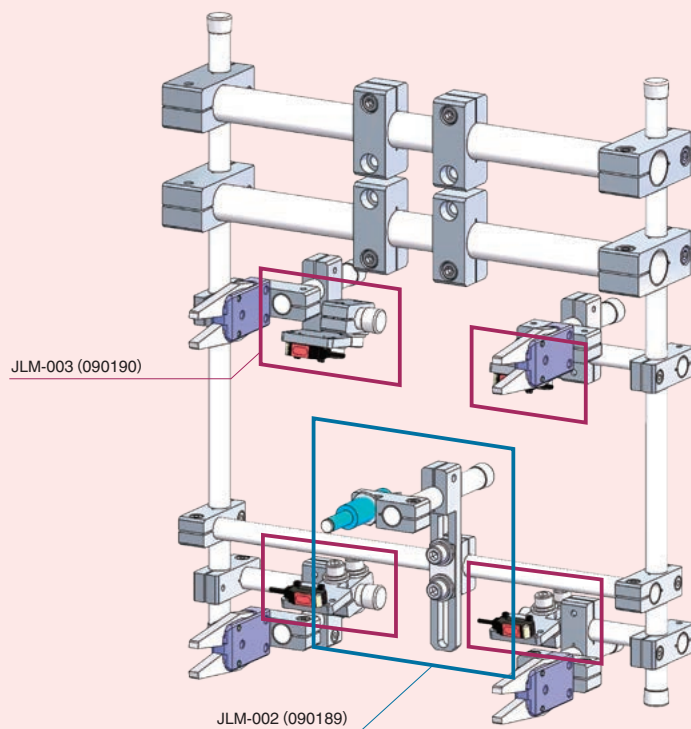

MEMO

A series of horizontal dashed lines for writing.



Let's Joint

- ▶ Combination of Eins parts makes building an E.O.A.T. for many different shape of products easy.
- ▶ Light weight and easy fabrication.
- ▶ Let's joint fittings are attached with bolts.

Frame / Module

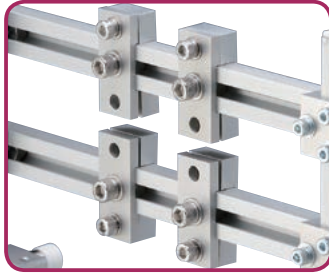

Grip

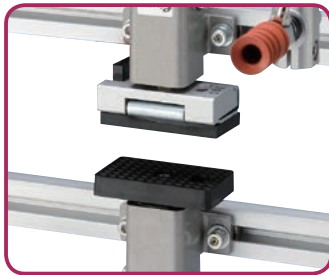

Suction

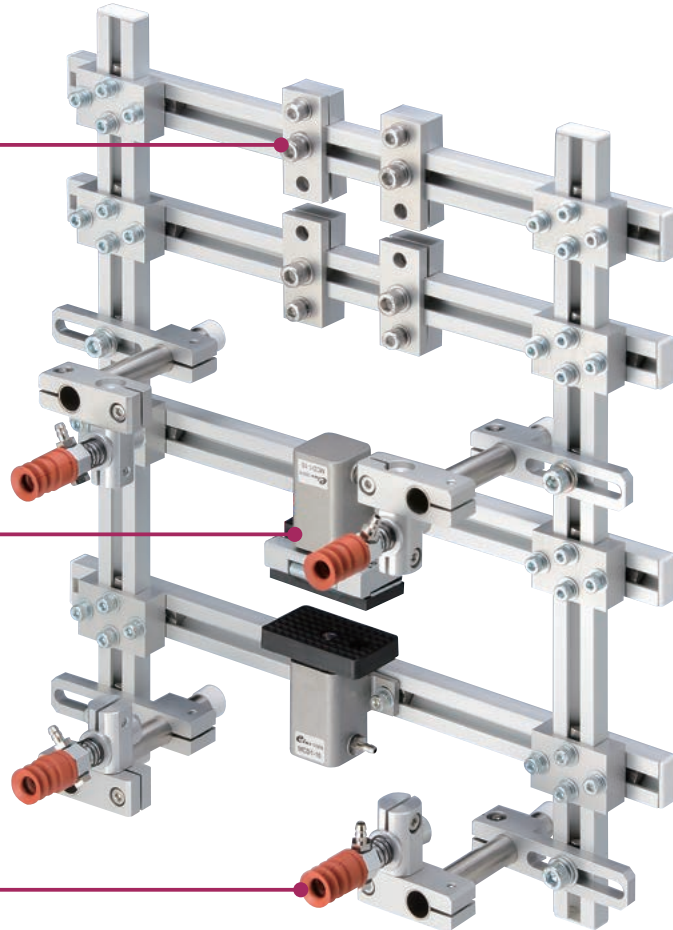
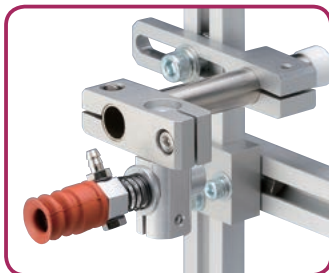

Tubing **6-1**

Let's Joint series parts based on three different size of aluminium profile extrusions to build an end of arm tool. Determine extract method first. And choose your favorite parts from the product list. The assemble them. Use let's joint modules in **5-40** to create your chuck plate easily.

Example of using other components parts

- ▶ Let's joint + Connector + Bracket + Nut

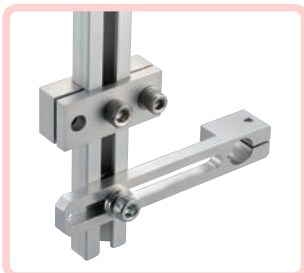

| | |
|----------------|------------------|
| Order code No. | 271520 |
| Standard | 10*20*500 |



| | |
|----------------|-------------------|
| Order code No. | 131130 |
| Standard | N01863-103 |



| | |
|----------------|--------------------------|
| Order code No. | 131222 |
| Standard | N01911-204-205SET |



| | |
|----------------|-------------------|
| Order code No. | 131056 |
| Standard | N01914-103 |



List of Let's Joint

Various parts can be attached to let's joint frame.

■ Specification

| Product name | | Order code No. | |
|-----------------|---------------------------------|-----------------------|------------|
| | | Standard | |
| Frame | Let's joint • PROFILE | | 271520 |
| | | | 10*20*500 |
| | | | 271521 |
| | | | 10*20*1000 |
| | | | 271515 |
| | | | 10*20*1500 |
| | | | 281807 |
| | | | 25*25*500 |
| | | | 281809 |
| | | | 25*25*1000 |
| | | | 281753 |
| | | | 25*25*1500 |
| | | | 281808 |
| | | | 25*50*500 |
| | | | 281810 |
| | 25*50*1000 | | |
| | 281754 | | |
| | 25*50*1500 | | |
| Profile end cap | Profile end cap • 10-20 | 131213 | |
| | | N01902-004 | |
| | Profile end cap • 25-25 | 131214 | |
| | N01902-005 | | |
| Profile end cap | Profile end cap • 25-50 | 131215 | |
| | | N01902-006 | |
| Connector set | Connector 20 • set A | 131220 | |
| | | N01911-201-202SET | |
| | Connector 20 • set B | 131221 | |
| | | N01911-201-203SET | |
| | Connector 20 • set C | 131222 | |
| | | N01911-204-205SET | |
| Connector | Cross connector • 20/25 • set A | 131223 | |
| | | N01911-208-106-201SET | |
| | Connector 25 • set A | 131224 | |
| | N01911-101-102SET | | |
| Connector | Cross connector • 20 | 131028 | |
| | | N01911-206 | |
| | Cross connector • 25 | 131019 | |
| | N01911-103 | | |

| Product name | | Order code No. | |
|----------------------------|----------------------------|----------------|------------|
| | | Standard | |
| Connector | Cross connector • 25/50 | | 131033 |
| | | | N01911-401 |
| | Cross connector • 50 | | 131032 |
| | | | N01911-301 |
| | Connector 20 • F | | 131029 |
| | | | N01911-207 |
| | Connector 20 • G | | 131031 |
| | | | N01911-209 |
| Block | Cylinder connector 25 • A | | 131020 |
| | | | N01911-104 |
| | Cylinder connector 25 • B | | 131021 |
| | | | N01911-105 |
| | Swing block • PT1/8 | | 131076 |
| | | | N01915-114 |
| | Connector block 50 • B | | 131040 |
| | | | N01912-203 |
| | Connector block • for GCYL | | 131039 |
| | | | N01912-202 |
| Bracket | Connector block • light | | 131038 |
| | | | N01912-106 |
| | Connector block 25/50 • A | | 131041 |
| | | | N01912-301 |
| | Connector block 25 • C | | 131035 |
| | | | N01912-103 |
| | Connector block 25 • D | | 131036 |
| | | | N01912-104 |
| | Slide bracket 40 • M3 | | 131158 |
| | | | N01863-214 |
| Bracket | Slide bracket 40 • M5 | | 131147 |
| | | | N01863-203 |
| | Slide bracket 40 • M6 | | 131156 |
| | | | N01863-212 |
| | Slide bracket 40 • PT1/8 | | 131154 |
| | | | N01863-210 |
| | Slide bracket 40 • W • M10 | | 131139 |
| | | | N01863-117 |
| Slide bracket 40 • W • M12 | | 131140 | |
| | | N01863-118 | |

Quick Chuck Change

Quick Chuck Change (Manual)

Tool Changer

Automated Chuck Exchange System

Grip

Mini Cylinder

Accessories for Mini Cylinder

Container Cylinders

Accessories for Container Cylinder

Grippers

Buffer Material

Suction

Suction Cups

Suction Stem

Pad in Pad

Air Ejector/Filter/Check Valve

Micro Mold E.O.A.T

Cut

Mini Air Nippers

Air Nippers

Frame/Module

Jungle Gym

Let's Joint

Rectangular Tube

Base Aluminum Material

Sliding Chuck

Tubing/Sensors

Tubing

Sensors

Other Products



















Others

Information

List of Let's Joint

| Product name | Order code No. Standard |
|-------------------------------------|-----------------------------|
| | |
| Slide bracket 40 • ϕ 8 | 131152 N01863-208 |
| Slide bracket • W • ϕ 8 | 131131 N01863-106 |
| Slide bracket 40 • W • ϕ 12 | 131132 N01863-107 |
| Slide bracket 40 • W • ϕ 20 | 131137 N01863-114 |
| Slide bracket 40 • T • W • ϕ 8 | 230051 XL0005-102 |
| Slide bracket 40 • T • ϕ 8 | 230056 XL0005-107 |
| Slide bracket 40 • T • ϕ 12 | 230052 XL0005-103 |
| Slide bracket 40 • T • ϕ 20 | 230054 XL0005-105 |
| Slide bracket 70 • M3 | 131159 N01863-217 |
| Slide bracket 70 • M5 | 131148 N01863-204 |
| Slide bracket 70 • M6 | 131157 N01863-213 |
| Slide bracket 70 • PT1/8 | 131155 N01863-211 |
| Slide bracket 70 • W • M10 | 131141 N01863-120 |
| Slide bracket 70 • W • M12 | 131142 N01863-121 |
| Slide bracket 70 • W • M17 | 131144 N01863-124 |
| Slide bracket 70 • ϕ 8 | 131153 N01863-209 |
| Slide bracket 70 • W • ϕ 8 | 131133 N01863-110 |
| Slide bracket 70 • W • ϕ 12 | 131130 N01863-103 |

| Product name | Order code No. Standard |
|-------------------------------------|-----------------------------|
| | |
| Slide bracket 70 • T • W • ϕ 8 | 230053 XL0005-104 |
| Slide bracket 70 • T • ϕ 8 | 230057 XL0005-108 |
| Slide bracket 70 • T • ϕ 12 | 230050 XL0005-101 |
| Slide bracket 70 • T • ϕ 20 | 230055 XL0005-106 |
| Swing bracket | 131065 N01915-102 |
| Connector bracket 25 • E | 131037 N01912-105 |
| Suction link bracket • M12 | 131090 N01918-201 |
| Cylinder bracket • ϕ 8 | 131075 N01915-113 |
| Cylinder bracket • ϕ 12 | 131074 N01915-112 |
| Cylinder bracket • ϕ 20 | 131066 N01915-103 |
| Link bracket 25/50 | 131034 N01911-402 |
| Chuck bracket • ϕ 12 | 131067 N01915-105 |
| Sensor bracket | 131077 N01915-201 |
| Nipper bracket • D | 131081 N01915-304 |
| Nipper bracket • E | 131082 N01915-305 |
| Bracket • NCON | 131083 N01915-401 |
| Bracket • ϕ 8 | 131073 N01915-111 |
| Bracket • ϕ 12 | 131071 N01915-109 |

| Product name | | Order code No. | | |
|--------------|------------------------------|-------------------------------------------------------------------------------------|-------------------------------------------------------------------------------------|-----------------------------|
| | | Standard | | |
| Bracket | Bracket • ϕ 20 |  | 131072 N01915-110 | |
| | Bracket • W • ϕ 8 |  | 131070 N01915-108 | |
| | Bracket • W • ϕ 12 |  | 131068 N01915-106 | |
| | Bracket • W • ϕ 20 |  | 131069 N01915-107 | |
| | Rotation bracket • ϕ 20 |  | 131064 N01915-101 | |
| Plate | Connect plate 20 • A |  | 131413 N01913-201 | |
| | Connect plate 25 • A |  | 131406 N01913-101 | |
| | Connect plate 25 • B |  | 131407 N01913-102 | |
| | Connect plate 25 • C |  | 131405 N01913-103 | |
| | Connect plate 25 • D |  | 131045 N01913-104 | |
| | Connect plate 25 • F |  | 131047 N01913-106 | |
| | Connect plate 25 • G |  | 131411 N01913-107 | |
| | Connect plate 25 • H |  | 131049 N01913-108 | |
| | Connect plate 25/50 • A |  | 131416 N01913-401 | |
| | Connect plate 50 • A |  | 131051 N01913-301 | |
| | Connect plate 50 • B |  | 131052 N01913-302 | |
| | Washer | Washer • A • for let's joint |  | 131087 N01918-102 |
| | | Washer • B • for let's joint |  | 131088 N01918-103 |

| Product name | | Order code No. | |
|--------------|-------------------------------------|---------------------------------------------------------------------------------------|-----------------------------|
| | | Standard | |
| Nut | Nut • M4 |  | 131061 N01914-108 |
| | Nut • M4 • 2P • 32, M5 • 2P • 28 |  | 131063 N01914-202 |
| | Nut • M4 • 2P • 38, M3 • 2P • 20 |  | 131062 N01914-201 |
| | Nut • M6 |  | 131056 N01914-103 |
| | Nut • M6 • 2P • 12 |  | 131055 N01914-102 |
| | Nut • M6 • 2P • 15 |  | 131054 N01914-101 |
| | Nut • M6 • 2P • 20 |  | 131058 N01914-105 |
| | Nut • M6 • 2P • 25 |  | 131059 N01914-106 |
| | Nut • M6 • 3P • 15 |  | 131057 N01914-104 |
| | Nut • M6 • 3P • 30 |  | 131060 N01914-107 |
| Nut plate | Nut plate • for slide bracket |  | 023197 CP-076 |
| Guide bar | Guide bar • 100 |  | 131084 N01916-201 |
| | Guide bar • 200 |  | 131085 N01916-202 |
| Joint | Joint • for let's joint |  | 131089 N01918-104 |
| Spacer | Spacer 25 • T5 • P25 |  | 131086 N01918-101 |
| Plate | Attach plate • A |  | 131091 |
| | | | N01918-301 |

Quick Chuck Change

Quick Chuck Change (Manual)

Tool Changer

Automated Chuck Exchange System

Grip

Mini Cylinder

Accessories for Mini Cylinder

Container Cylinders

Accessories for Container Cylinder

Grippers

Buffer Material

Suction

Suction Cups

Suction Stem

Pad in Pad

Air Ejector/Filter/Check Valve

Micro Mold E.O.A.T

Cut

Mini Air Nippers

Air Nippers

Frame/Module

Jungle Gym

Let's Joint

Rectangular Tube

Base Aluminum Material

Sliding Chuck

Tubing/Sensors

Tubing

Sensors

Other Products

Others

Information



Base Frame Module

Modularized chuck parts for let's joint.

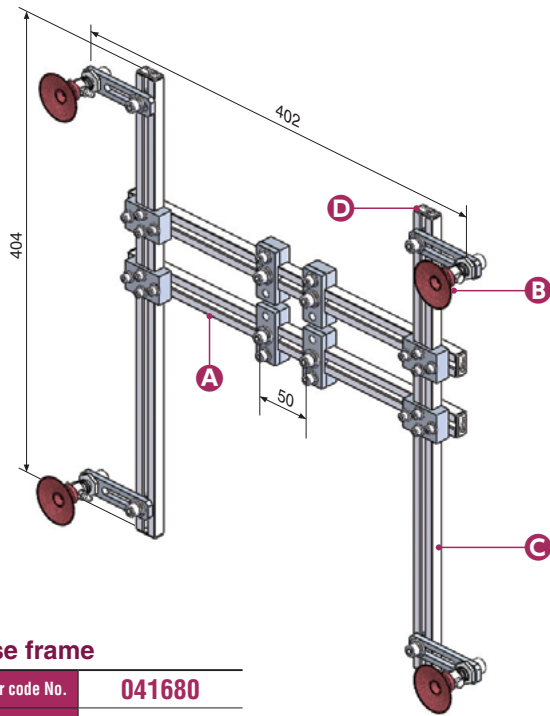

Base frame

| | |
|----------------|------------------|
| Order code No. | 041680 |
| Standard | EFCK-5600 |

● Weight : 775g

| Configuration module | Standard | Order code No. | No. of uses | Details |
|---------------------------------------------|------------|----------------|-------------|---------|
| A : Base frame · for let's joint | EFCK-5601 | 041681 | 2 | 5-40 |
| B : Suction module · for let's joint | LSM-003 | 110571 | 4 | 5-40 |
| C : Let's joint · PROFILE | 10*20*500 | 271520 | 2 | 5-37 |
| D : Profile end cap · 10-20 | N01902-004 | 131213 | 4 | 5-37 |

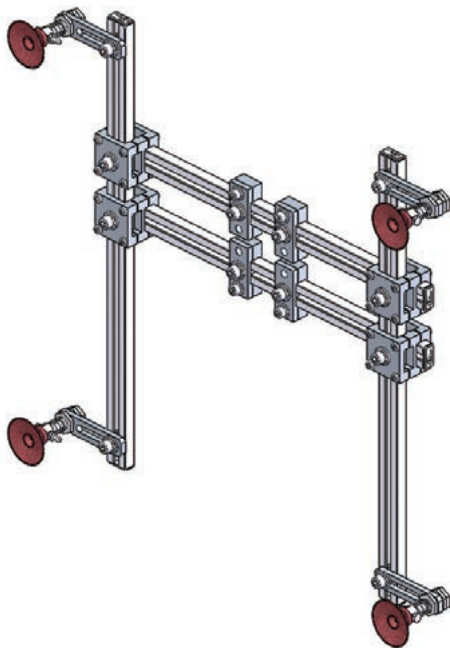

Base frame

| | |
|----------------|------------------|
| Order code No. | 041677 |
| Standard | EFCK-5500 |

● Weight : 924g

Base frame · for let's joint components of EFCK-5600...**A**

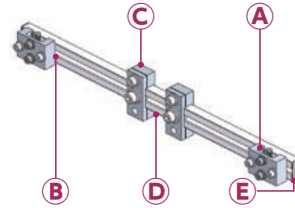

| | |
|----------------|------------------|
| Order code No. | 041681 |
| Standard | EFCK-5601 |

● Weight : 180g

| Configuration parts | Standard | Order code No. | No. of uses | Details |
|------------------------------------|-------------------|----------------|-------------|---------|
| A : Connector 20 · F | N01911-207 | 131029 | 2 | 5-37 |
| B : Nut · M4 | N01914-108 | 131061 | 8 | 5-39 |
| C : Connector 20 · set C | N01911-204-205set | 131222 | 2 | 5-37 |
| D : Let's joint · PROFILE | 10*20*500 | 271520 | 1 | 5-37 |
| E : Profile end cap · 10-20 | N01902-004 | 131213 | 2 | 5-37 |

Suction module · for let's joint components of EFCK-5600...**B**

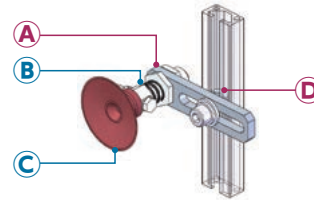

| | |
|----------------|----------------|
| Order code No. | 110571 |
| Standard | LSM-003 |

● Weight : 50g

| Configuration parts | Standard | Order code No. | No. of uses | Details |
|--------------------------------------------------|------------|----------------|-------------|---------|
| A : Slide bracket 40 · W · M12 | N01863-118 | 131140 | 1 | 5-22 |
| B : Suction stem small | VFIL-S-5A | 210974 | 1 | 3-23 |
| C : Suction cups (standard/silicon/brown) | VAPH-40C | 210196 | 1 | 3-5 |
| D : Nut · M6 | N01914-103 | 131056 | 1 | 5-39 |

Base frame · for let's joint

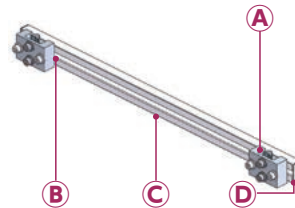

| | |
|----------------|------------------|
| Order code No. | 041682 |
| Standard | EFCK-5602 |

● Weight : 130g

| Configuration parts | Standard | Order code No. | No. of uses | Details |
|------------------------------------|------------|----------------|-------------|---------|
| A : Connector 20 · F | N01911-207 | 131029 | 2 | 5-37 |
| B : Nut · M4 | N01914-108 | 131061 | 8 | 5-39 |
| C : Let's joint · PROFILE | 10*20*500 | 271520 | 1 | 5-37 |
| D : Profile end cap · 10-20 | N01902-004 | 131213 | 2 | 5-37 |

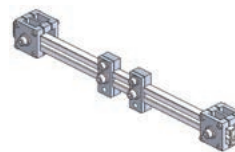

Base frame · for let's joint

| | |
|----------------|------------------|
| Order code No. | 041678 |
| Standard | EFCK-5501 |

● Weight : 253g

Base frame · for let's joint

| | |
|----------------|------------------|
| Order code No. | 041679 |
| Standard | EFCK-5502 |

● Weight : 203g

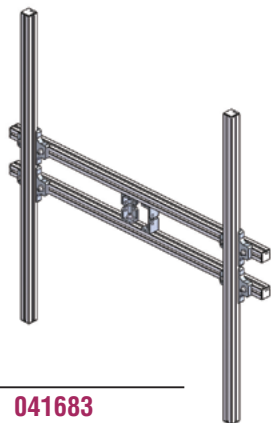

Base frame

| | |
|----------------|------------------|
| Order code No. | 041683 |
| Standard | EFCK-7000 |

● Weight : 3,114g

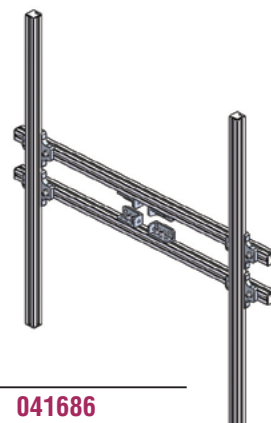

Base frame

| | |
|----------------|------------------|
| Order code No. | 041686 |
| Standard | EFCK-7500 |

● Weight : 3,476g



Base frame • for let's joint

| | |
|----------------|------------------|
| Order code No. | 041684 |
| Standard | EFCK-7001 |

● Weight : 1,030g



Base frame • for let's joint

| | |
|----------------|------------------|
| Order code No. | 041685 |
| Standard | EFCK-7002 |

● Weight : 961g



Base frame • for let's joint

| | |
|----------------|------------------|
| Order code No. | 041687 |
| Standard | EFCK-7501 |

● Weight : 1,211g

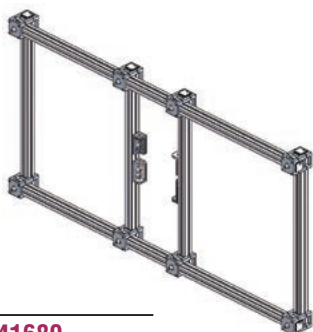

Base frame

| | |
|----------------|------------------|
| Order code No. | 041689 |
| Standard | EFCK-7600 |

● Weight : 3,992g

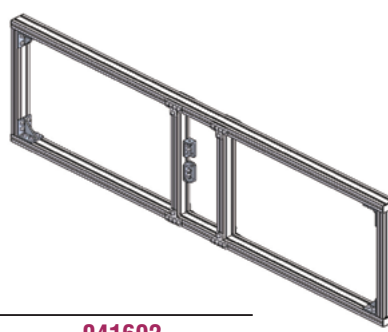

Base frame

| | |
|----------------|------------------|
| Order code No. | 041692 |
| Standard | EFCK-8000 |

● Weight : 7,612g



Base frame • for let's joint

| | |
|----------------|------------------|
| Order code No. | 041690 |
| Standard | EFCK-7601 |

● Weight : 772g

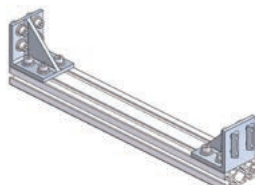

Base frame • for let's joint

| | |
|----------------|------------------|
| Order code No. | 041694 |
| Standard | EFCK-8002 |

● Weight : 822g

▶ Discontinued product

(Following module product is created by combination of components.)



Base frame • for let's joint

| Configuration parts | Standard | Order code No. |
|-------------------------|--------------------|----------------|
| Connector 25 • set A | N01911-101-102 SET | 131224 |
| Profile end cap • 25-25 | N01902-005 | 131214 |
| PROFILE25*25 | 25*25*500 | 281807 |

* PROFILE length is 500mm if only PROFILE is ordered.

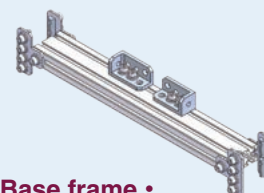

Base frame • for let's joint

| Configuration parts | Standard | Order code No. |
|------------------------|------------|----------------|
| Connector block 25 • D | N01912-104 | 131036 |
| Nut • M6 • 2P • 15 | N01914-101 | 131054 |
| Connector plate 25 • D | N01913-104 | 131045 |
| PROFILE 25*50 | 25*50*500 | 281808 |

* PROFILE length is 500mm if only PROFILE is ordered.

Quick Chuck Change

Quick Chuck Change (Manual)

Tool Changer

Automated Chuck Exchange System

Grip

Mini Cylinder

Accessories for Mini Cylinder

Container Cylinders

Accessories for Container Cylinder

Grippers

Buffer Material

Suction

Suction Cups

Suction Stem

Pad in Pad

Air Ejector/Filter/Check Valve

Micro Mold E.O.A.T

Cut

Mini Air Nippers

Air Nippers

Frame/Module

Jungle Gym

Let's Joint

Rectangular Tube

Base Aluminum Material

Sliding Chuck

Tubing/Sensors

Tubing

Sensors

Other Products

Others

Information



Suction Module

Modularized chuck parts for let's joint.

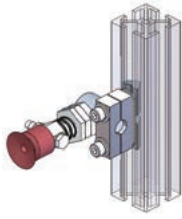

Suction module • for let's joint

| | |
|----------------|----------------|
| Order code No. | 110569 |
| Standard | LSM-001 |

● Weight : 75g ● Suction stem : VFIL-S-5A

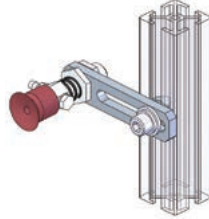

Suction module • for let's joint

| | |
|----------------|----------------|
| Order code No. | 110570 |
| Standard | LSM-002 |

● Weight : 38g ● Suction stem : VFIL-S-5A

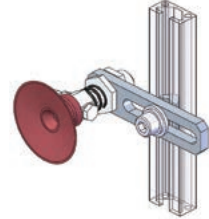

Suction module • for let's joint

| | |
|----------------|----------------|
| Order code No. | 110571 |
| Standard | LSM-003 |

● Weight : 50g ● Suction stem : VFIL-S-5A

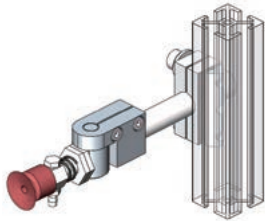

Suction module • for let's joint

| | |
|----------------|----------------|
| Order code No. | 110572 |
| Standard | LSM-004 |

● Weight : 95g ● Suction stem : VFIL-S-5A

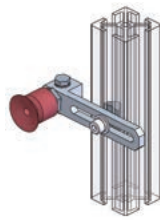

Suction module • for let's joint

| | |
|----------------|----------------|
| Order code No. | 110573 |
| Standard | LSM-005 |

● Weight : 24g ● Suction stem : N01892-301

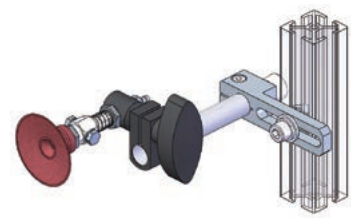

Suction module • for let's joint

| | |
|----------------|----------------|
| Order code No. | 110574 |
| Standard | LSM-006 |

● Weight : 132g ● Suction stem : VFILB2-SH

Example of using suction module

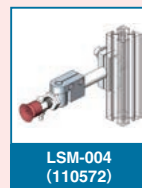
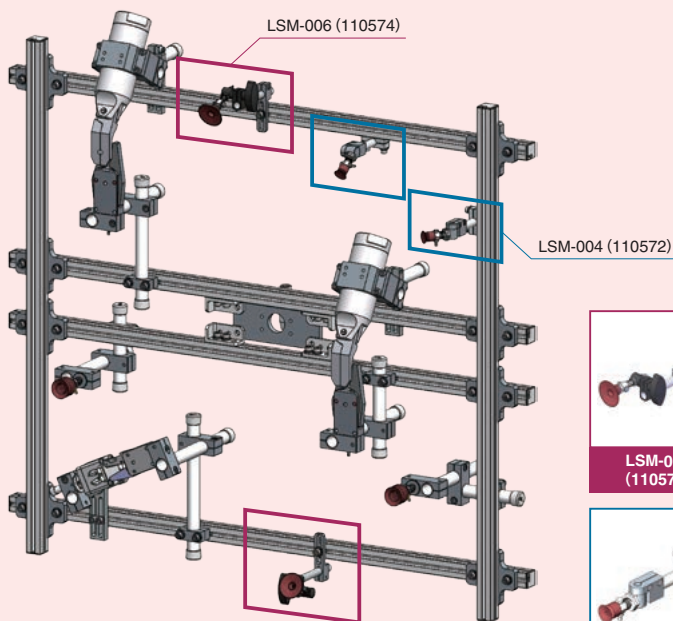

Discontinued product

(Following module product is created by combination of components.)

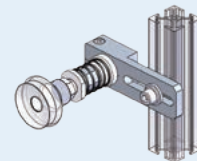

Suction module • for let's joint

| Configuration parts | Standard | Order code No. |
|--------------------------------------|------------------|----------------|
| Bellows type suction cups 1.5-stage | SFSGA33SI-PT1/8M | 183879 |
| Suction Stem Non-Rotate Mini (Large) | VFIL-H | 210788 |
| Slide bracket 40 · W · φ 20 | N01863-114 | 131137 |
| Nut · M6 | N01914-103 | 131056 |



Gripper Module

Modularized chuck parts for let's joint.

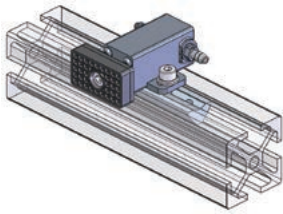

Gripper module • for let's joint (UMCD)

| | |
|----------------|----------------|
| Order code No. | 110577 |
| Standard | LGM-002 |

● Weight : 46g ● Micro mini cylinder : UMCD-10

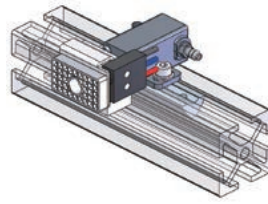

Gripper module • for let's joint (UMCD)

| | |
|----------------|----------------|
| Order code No. | 110579 |
| Standard | LGM-004 |

● Weight : 64g ● Micro mini cylinder : UMCD-10

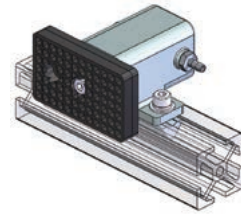

Gripper module • for let's joint (MCD1)

| | |
|----------------|----------------|
| Order code No. | 110580 |
| Standard | LGM-005 |

● Weight : 131g ● Mini cylinder : MCD1-10

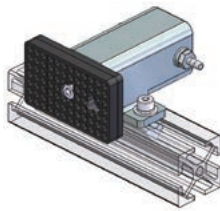

Gripper module • for let's joint (MCD1)

| | |
|----------------|----------------|
| Order code No. | 110581 |
| Standard | LGM-006 |

● Weight : 146g ● Mini cylinder : MCD1-20

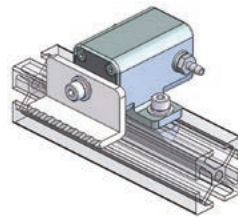

Gripper module • for let's joint (MCD1)

| | |
|----------------|----------------|
| Order code No. | 110582 |
| Standard | LGM-007 |

● Weight : 117g ● Mini cylinder : MCD1-10

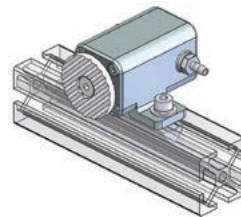

Gripper module • for let's joint (MCD1)

| | |
|----------------|----------------|
| Order code No. | 110583 |
| Standard | LGM-008 |

● Weight : 98g ● Mini cylinder : MCD1-10

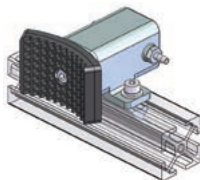

Gripper module • for let's joint (MCD1)

| | |
|----------------|----------------|
| Order code No. | 110584 |
| Standard | LGM-009 |

● Weight : 132g ● Mini cylinder : MCD1-20

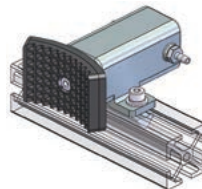

Gripper module • for let's joint (MCD1)

| | |
|----------------|----------------|
| Order code No. | 110585 |
| Standard | LGM-010 |

● Weight : 147g ● Mini cylinder : MCD1-20

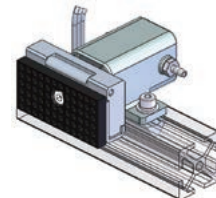

Gripper module • for let's joint (MCD1)

| | |
|----------------|----------------|
| Order code No. | 110586 |
| Standard | LGM-011 |

● Weight : 147g ● Mini cylinder : MCD1-10

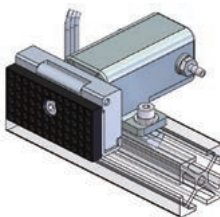

Gripper module • for let's joint (MCD1)

| | |
|----------------|----------------|
| Order code No. | 110587 |
| Standard | LGM-012 |

● Weight : 162g ● Mini cylinder : MCD1-20

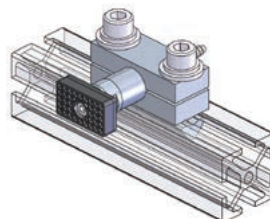

Gripper module • for let's joint (MCP)

| | |
|----------------|----------------|
| Order code No. | 110588 |
| Standard | LGM-013 |

● Weight : 42g ● Cylinder for pipe attachment : MCP-1210

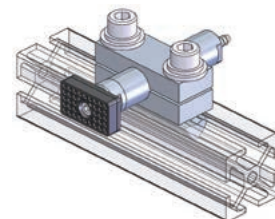

Gripper module • for let's joint (MCP)

| | |
|----------------|----------------|
| Order code No. | 110589 |
| Standard | LGM-014 |

● Weight : 43g ● Cylinder for pipe attachment : MCP-1220

Quick Chuck Change

Quick Chuck Change (Manual)

Tool Changer

Automated Chuck Exchange System

Grip

Mini Cylinder

Accessories for Mini Cylinder

Container Cylinders

Accessories for Container Cylinder

Grippers

Buffer Material

Suction

Suction Cups

Suction Stem

Pad in Pad

Air Ejector/Filter/Check Valve

Micro Mold E.O.A.T

Cut

Mini Air Nippers

Air Nippers

Frame/Module

Jungle Gym

Let's Joint

Rectangular Tube

Base Aluminum Material

Sliding Chuck

Tubing/Sensors

Tubing

Sensors

Other Products

Others

Information

Gripper Module

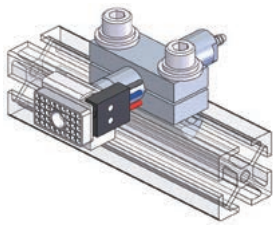

Gripper module • for let's joint (MCP)

| | |
|----------------|----------------|
| Order code No. | 110590 |
| Standard | LGM-015 |

● Weight : 61g ● Cylinder for pipe attachment : MCP-1220

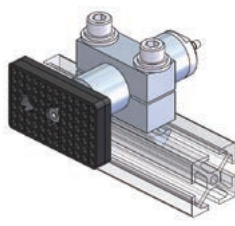

Gripper module • for let's joint (MCP)

| | |
|----------------|----------------|
| Order code No. | 110592 |
| Standard | LGM-017 |

● Weight : 148g ● Cylinder for pipe attachment : MCP-2010

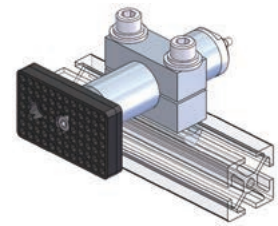

Gripper module • for let's joint (MCP)

| | |
|----------------|----------------|
| Order code No. | 110593 |
| Standard | LGM-018 |

● Weight : 168g ● Cylinder for pipe attachment : MCP-2020

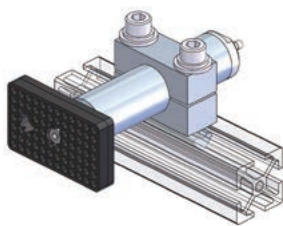

Gripper module • for let's joint (MCP)

| | |
|----------------|----------------|
| Order code No. | 110594 |
| Standard | LGM-019 |

● Weight : 158g ● Cylinder for pipe attachment : MCP-2030

Example of using gripper module

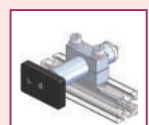
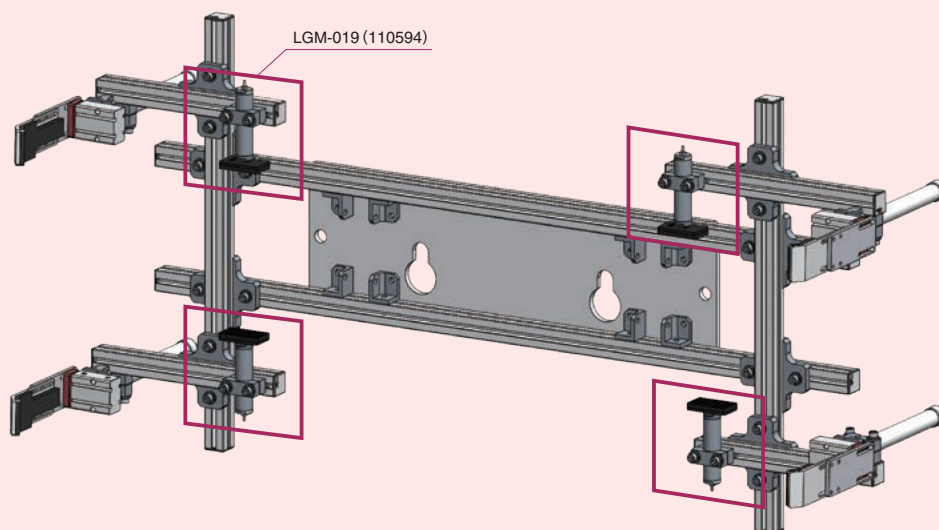

LGM-019
(110594)

▶ **Discontinued product** (Following module product is created by combination of components.)

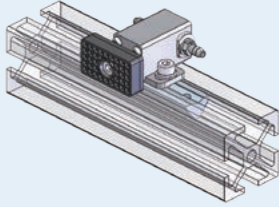

Gripper module for let's joint (UMCD)

| Configuration parts | Standard | Order code No. |
|---------------------------------------------|------------|----------------|
| Pad rectangle black for micro mini cylinder | CPUM-01 | 022797 |
| Micro mini cylinders | UMCD-5 | 200122 |
| Fitting | BF-3 | 010473 |
| Nut · M4 · 2P · 38, M3 · 2P · 20 | N01914-201 | 131062 |

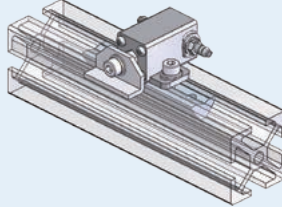

Gripper module for let's joint (UMCD)

| Configuration parts | Standard | Order code No. |
|--------------------------------------|------------|----------------|
| Claw L shape for micro mini cylinder | CPUM-02 | 022798 |
| Micro mini cylinders | UMCD-5 | 200122 |
| Fitting | BF-3 | 010473 |
| Nut · M4 · 2P · 38, M3 · 2P · 20 | N01914-201 | 131062 |

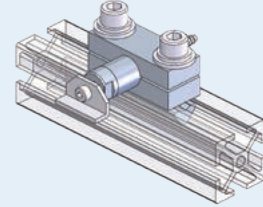

Gripper module for let's joint (MCP)

| Configuration parts | Standard | Order code No. |
|--------------------------------------|------------|----------------|
| Claw L shape for micro mini cylinder | CPUM-02 | 022798 |
| Cylinder for pipe attachment | MCP-1210 | 122824 |
| Chuck bracket · ϕ 12 | N01915-105 | 131067 |
| Nut · M6 · 3P · 15 | N01914-104 | 131057 |

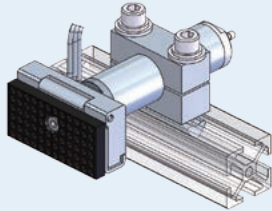

Gripper module for let's joint (MCP)

| Configuration parts | Standard | Order code No. |
|---------------------------------------------|------------|----------------|
| Pad rectangle w/ black SW for mini cylinder | KRC1-5000 | 101714 |
| Cylinder for pipe attachment | MCP-2020 | 122827 |
| Bracket · W · ϕ 20 | N01915-107 | 131069 |
| Nut · M6 · 3P · 15 | N01914-104 | 131057 |

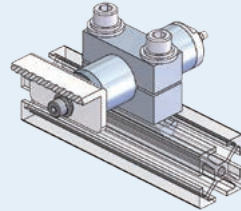

Gripper module for let's joint (MCP)

| Configuration parts | Standard | Order code No. |
|--------------------------------|------------|----------------|
| Claw L shape for mini cylinder | CP-014 | 370073 |
| Cylinder for pipe attachment | MCP-2010 | 122826 |
| Bracket · W · ϕ 20 | N01915-107 | 131069 |
| Nut · M6 · 3P · 15 | N01914-104 | 131057 |

Quick Chuck Change

Quick Chuck Change (Manual)

Tool Changer

Automated Chuck Exchange System

Grip

Mini Cylinder

Accessories for Mini Cylinder

Container Cylinders

Accessories for Container Cylinder

Grippers

Buffer Material

Suction

Suction Cups

Suction Stem

Pad in Pad

Air Ejector/Filter/Check Valve

Micro Mold E.O.A.T

Cut

Mini Air Nippers

Air Nippers

Frame/Module

Jungle Gym

Let's Joint

Rectangular Tube

Base Aluminum Material

Sliding Chuck

Tubing/Sensors

Tubing

Sensors

Other Products

Others

Information



Limit Switch Module

Modularized chuck parts for let's joint.

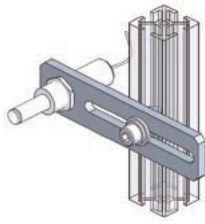

Limit switch module • for let's joint

| | |
|----------------|----------------|
| Order code No. | 110597 |
| Standard | LLM-001 |

● Weight : 55g

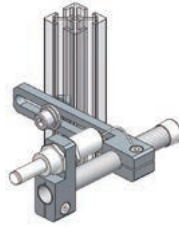

Limit switch module • for let's joint

| | |
|----------------|----------------|
| Order code No. | 110598 |
| Standard | LLM-002 |

● Weight : 86g

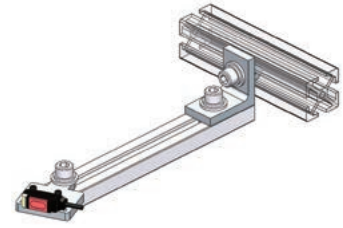

Limit switch module • for let's joint

| | |
|----------------|----------------|
| Order code No. | 110599 |
| Standard | LLM-003 |

● Weight : 117g

Example of using limit switch module

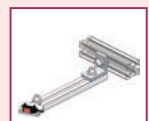
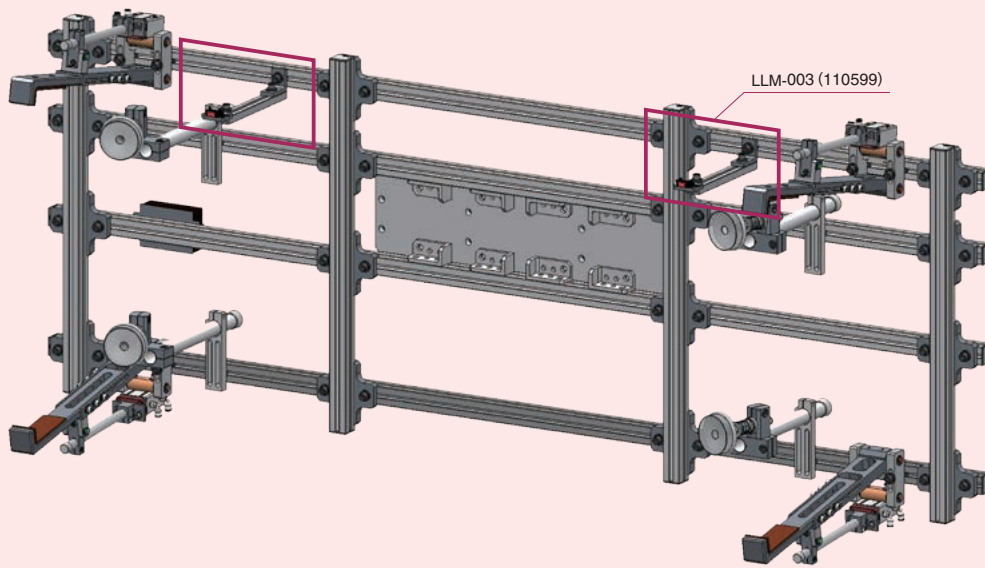

LLM-003
(110599)

MEMO

A series of horizontal dashed lines for writing.



Rectangular Tube

- ▶ Light weight, strong, and better rotate resistance.
- ▶ Combination of Eins parts makes building an E.O.A.T. for many different shape of products easy.

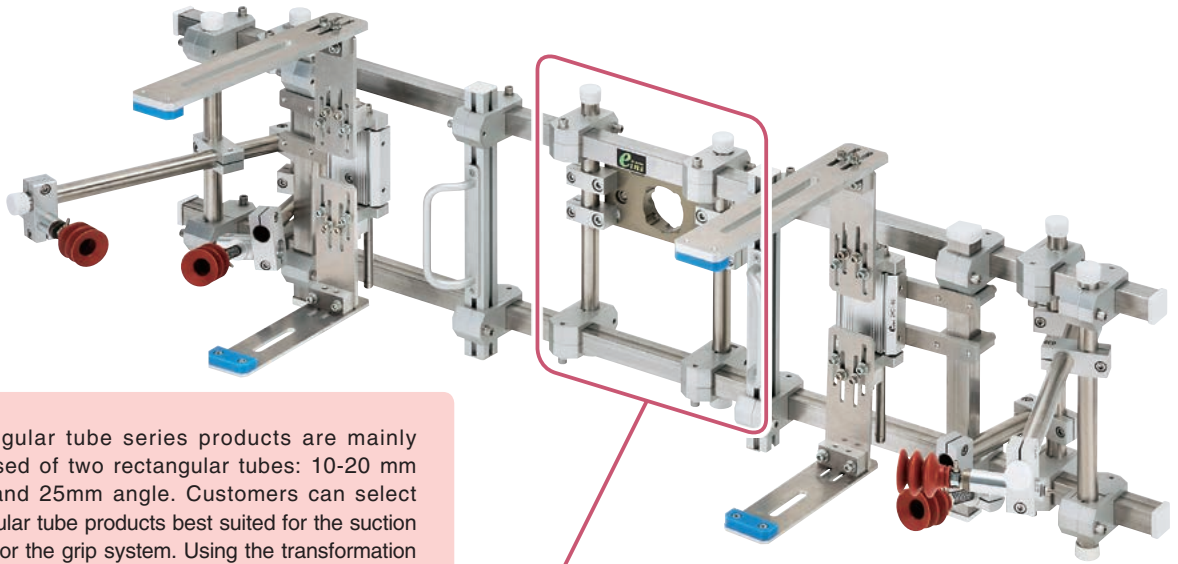

Rectangular tube series products are mainly composed of two rectangular tubes: 10-20 mm angle and 25mm angle. Customers can select rectangular tube products best suited for the suction system or the grip system. Using the transformation block allows combinations of jungle gym parts. Using the transformation block allows combinations of jungle gym parts.

Frame / Module • Rectangular Tube

Attachment bracket •
φ 20 • M8



Tubing **6-1**

Rectangular tube



Jungle gym
SS pipe φ 20



Cross connector •
25-25



Conversion block • 25-φ20



Rectangular Tube / Tube End Cap

Attaches various kinds of components based on the rectangular tube.

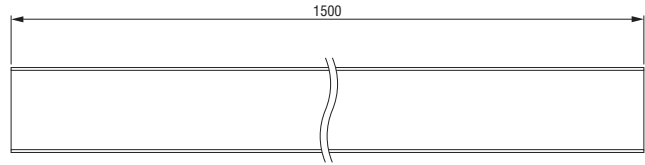
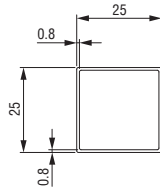
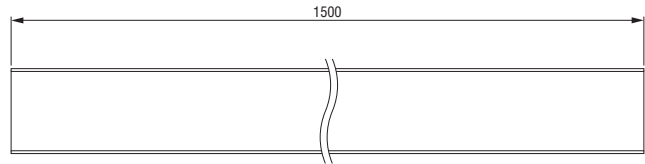
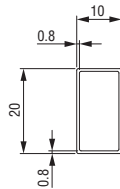

Rectangular tube

*Diameter of a pipe may expand when you cut the pipe.

| | |
|----------------|--------------------|
| Order code No. | 185124 |
| Standard | S10*20*1500 |

● Weight : 535g

| | |
|----------------|--------------------|
| Order code No. | 185125 |
| Standard | S25*25*1500 |

● Weight : 895g

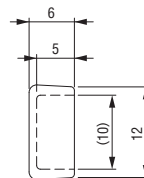
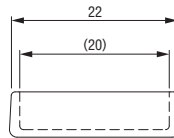

Tube end cap • 10*20

| | |
|----------------|--------------------|
| Order code No. | 185219 |
| Standard | S-CAP 10-20 |

● Weight : 1g

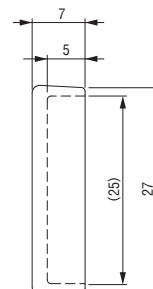
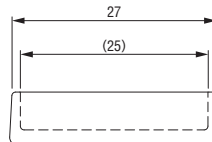
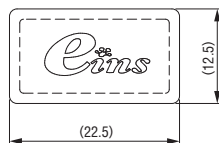

Tube end cap • 25*25

| | |
|----------------|--------------------|
| Order code No. | 185218 |
| Standard | S-CAP 25-25 |

● Weight : 3g

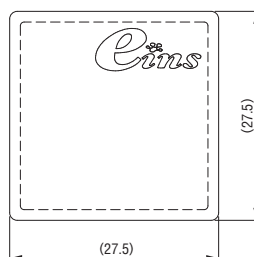

Quick Chuck Change

Quick Chuck Change (Manual)

Tool Changer

Automated Chuck Exchange System

Grip

Mini Cylinder

Accessories for Mini Cylinder

Container Cylinders

Accessories for Container Cylinder

Grippers

Buffer Material

Suction

Suction Cups

Suction Stem

Pad in Pad

Air Ejector / Filter / Check Valve

Micro Mold E.O.A.T

Cut

Mini Air Nippers

Air Nippers

Frame/Module

Jungle Gym

Let's Joint

Rectangular Tube

Base Aluminum Material

Sliding Chuck

Tubing/Sensors

Tubing

Sensors

Other Products

Others

Information



Rectangular Tube Series Parts

Securely fixes the Let's SS square pipe by precision processing.

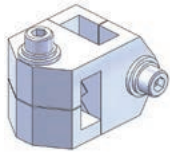

Cross connector • 10-20

| | |
|----------------|----------------------|
| Order code No. | 185126 |
| Standard | S-CROSS 10-20 |

● Weight : 102g

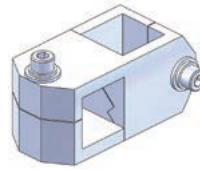
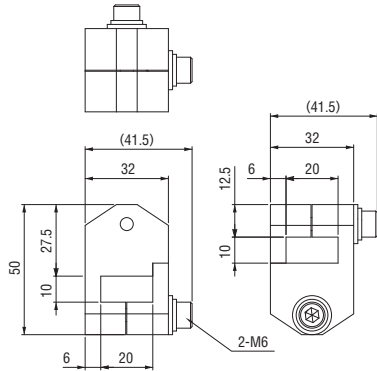

Cross connector • 25-25

| | |
|----------------|----------------------|
| Order code No. | 185127 |
| Standard | S-CROSS 25-25 |

● Weight : 170g

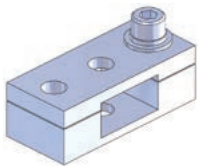
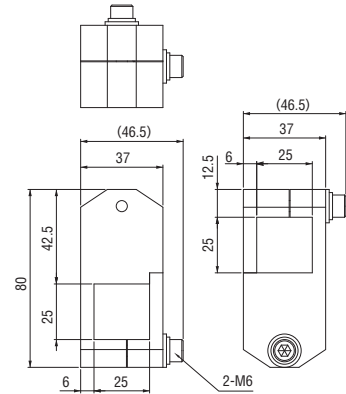

Attach bracket • 10-20 • M6

| | |
|----------------|--------------------------|
| Order code No. | 185128 |
| Standard | S-ATBR 10-20 • M6 |

● Weight : 30g

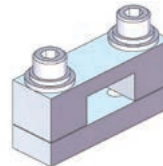
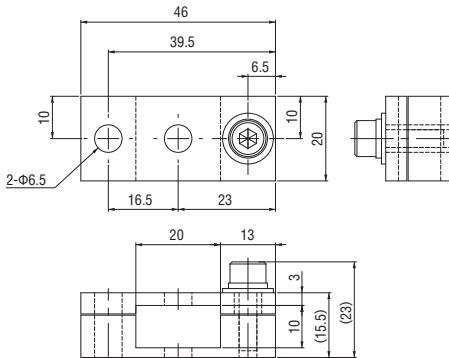

Slide bracket • 10-20

| | |
|----------------|---------------------|
| Order code No. | 185129 |
| Standard | S-SLBR 10-20 |

● Weight : 55g

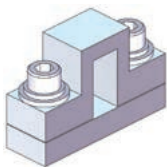
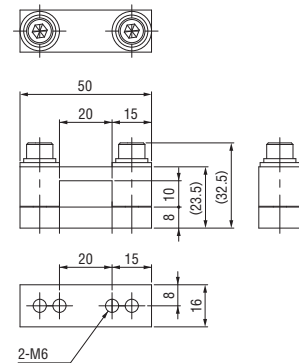

Slide bracket • 20-10

| | |
|----------------|---------------------|
| Order code No. | 185130 |
| Standard | S-SLBR 20-10 |

● Weight : 57g

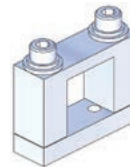
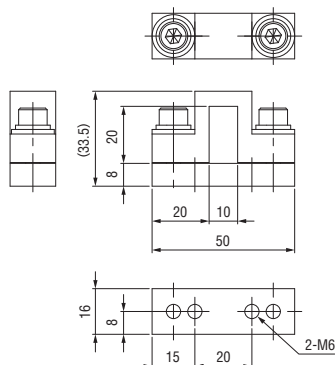

Slide bracket • 25-25

| | |
|----------------|---------------------|
| Order code No. | 185131 |
| Standard | S-SLBR 25-25 |

● Weight : 73g

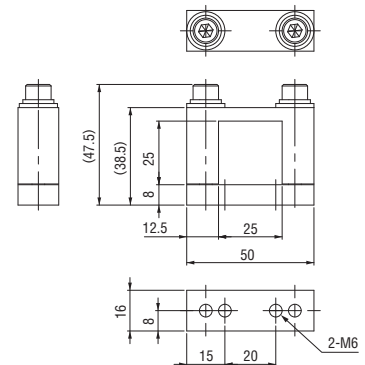

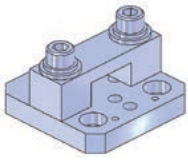

Bracket • 10 • MCD

| | |
|----------------|-------------------|
| Order code No. | 185132 |
| Standard | S-BR10 MCD |

● Weight : 87g

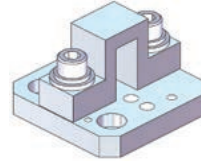
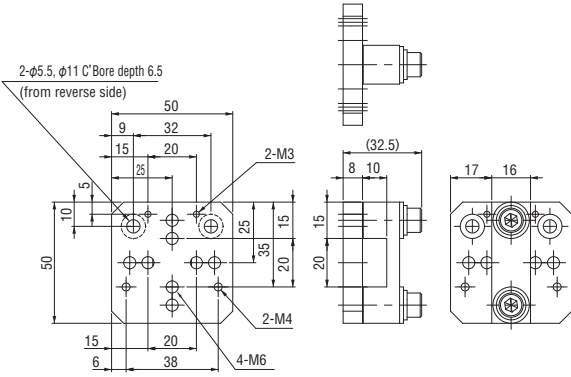

Bracket • 20 • MCD

| | |
|----------------|-------------------|
| Order code No. | 185133 |
| Standard | S-BR20 MCD |

● Weight : 90g

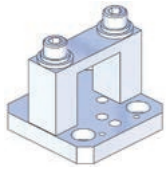
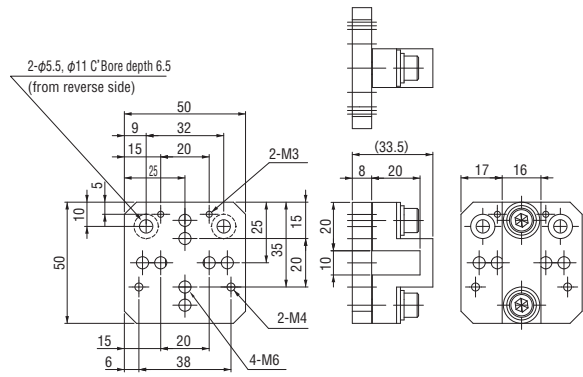

Bracket • 25 • MCD

| | |
|----------------|-------------------|
| Order code No. | 185134 |
| Standard | S-BR25 MCD |

● Weight : 105g

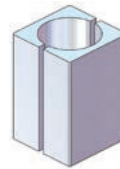
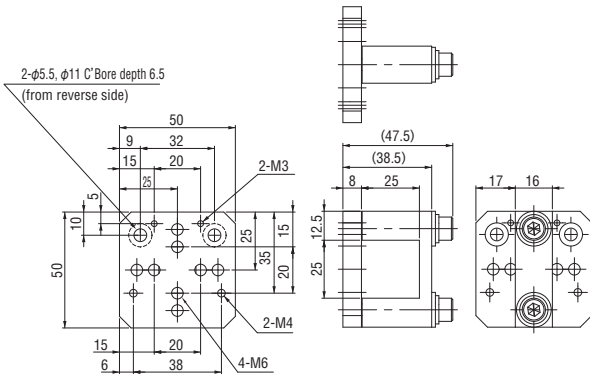

Conversion block • 25 • φ20

| | |
|----------------|--------------------|
| Order code No. | 185135 |
| Standard | S-CBL25-D20 |

● Weight : 31g

Convert to rectangular tube 25×25 inner dimension to jungle gym φ 20.

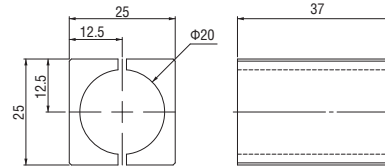

Notes on use

Reverse attachment prevents fixing of conversion block.

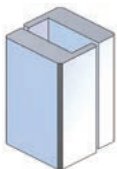
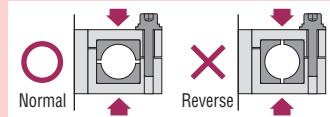

Conversion block • 25-10-20

| | |
|----------------|----------------------|
| Order code No. | 185136 |
| Standard | S-CBL25-10-20 |

● Weight : 42g

Convert to rectangular tube 25×25 inner dimension to rectangular tube 10×20.

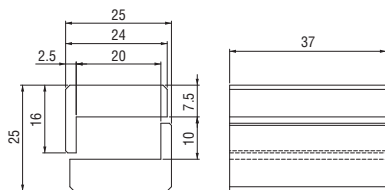

Notes on use

Reverse attachment prevents fixing of conversion block.

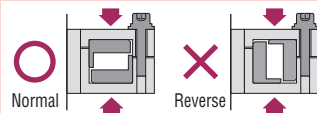

Leading connection

| | Countermeasures | Page of details |
|-----------------|-------------------------|----------------------|
| Pitch 20-M3 | Micro mini cylinder | 2-4 |
| Pitch 38-M4 | Mini cylinder | 2-4 |
| Pitch 32-C'Bore | Mini container cylinder | 2-17 |
| Pitch 20-M6 | Slide bracket φ8, φ12 | 5-15 |
| | Slide bracket | 5-21,22,23,24 |
| | Nipper bracket | 5-38 |
| | Bracket NCON | 5-38 |

Quick Chuck Change

Quick Chuck Change (Manual)

Tool Changer

Automated Chuck Exchange System

Grip

Mini Cylinder

Accessories for Mini Cylinder

Container Cylinders

Accessories for Container Cylinder

Grippers

Buffer Material

Suction

Suction Cups

Suction Stem

Pad in Pad

Air Ejector/Filter/Check Valve

Micro Mold E.O.A.T

Cut

Mini Air Nippers

Air Nippers

Frame/Module

Jungle Gym

Let's Joint

Rectangular Tube

Base Aluminum Material

Sliding Chuck

Tubing/Sensors

Tubing

Sensors

Other Products

Others

Information

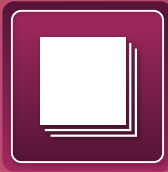

▶ Aluminum plate

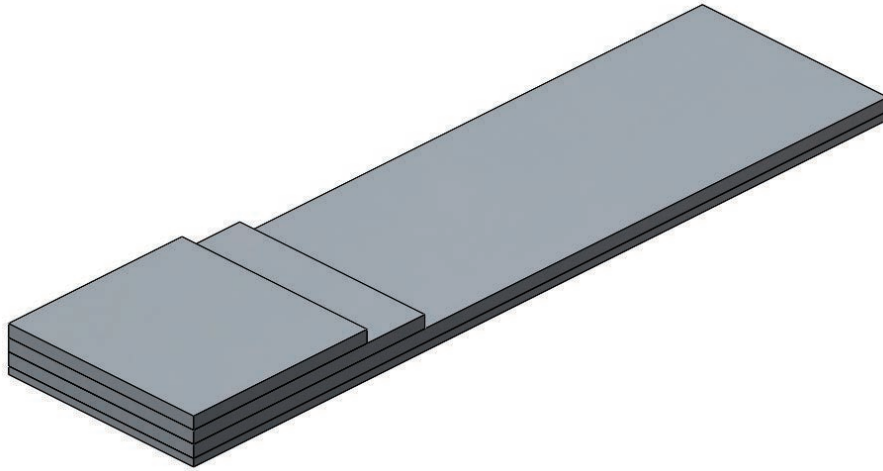

▶ Aluminum angle

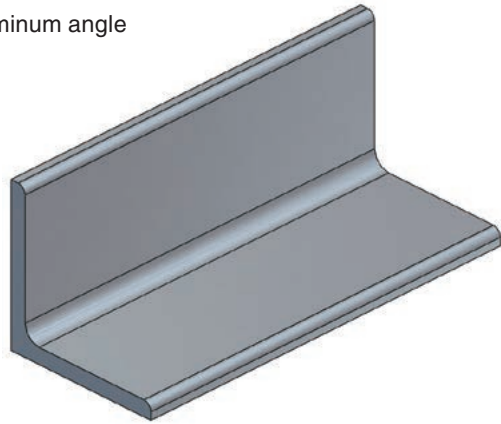

▶ Aluminum flat strip

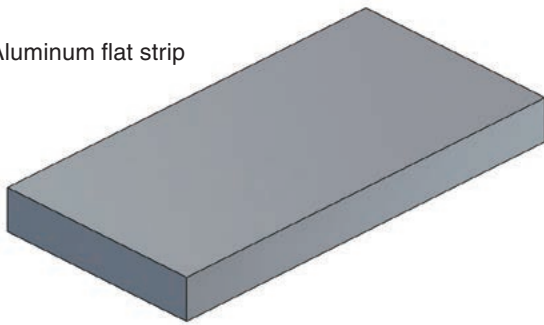

■ Specification

| Product name | Standard | Order code No. | Weight (g) | Remarks |
|---------------------|-------------|----------------|------------|-----------------------|
| Aluminum plate | 3T*400*1200 | 370029 | 3,920 | Material code : A5052 |
| | 5T*400*300 | 370028 | 1,630 | Material code : A5052 |
| | 5T*400*400 | 370027 | 2,180 | Material code : A5052 |
| | 5T*400*1200 | 370026 | 6,530 | Material code : A5052 |
| Aluminum angle | 3T*30*30*2M | 370074 | 900 | Material code : A5052 |
| | 4T*40*40*2M | 370075 | 1,670 | Material code : A6063 |
| | 5T*30*30*2M | 370077 | 1,400 | Material code : A6063 |
| | 5T*50*50*2M | 370076 | 2,440 | Material code : A6063 |
| Aluminum flat strip | 10T*30*2M | 370373 | 1,470 | Material code : A6063 |
| | 10T*50*2M | 370374 | 2,630 | Material code : A6063 |

► Aluminum angle

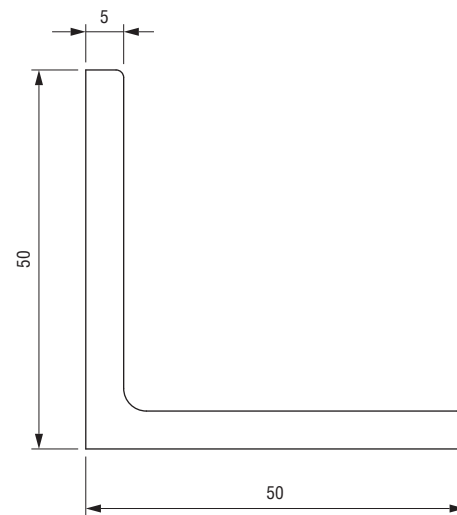
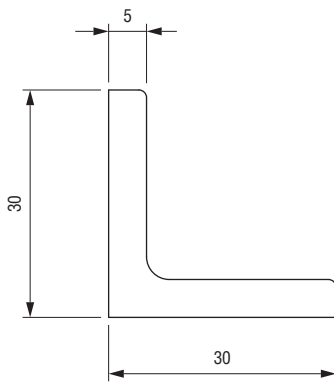
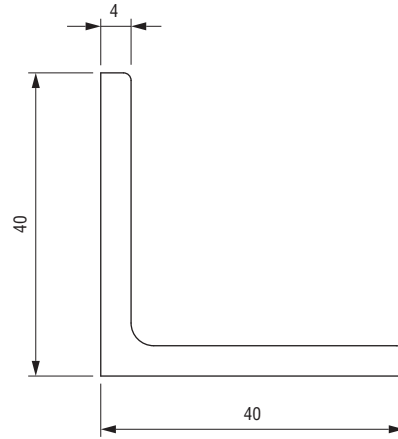
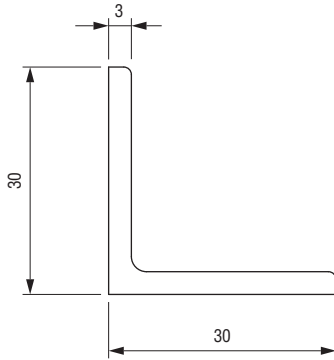

► Aluminum flat strip

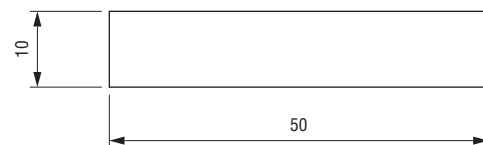
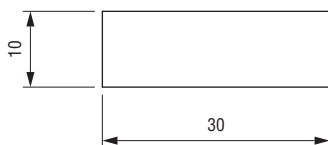

Quick Chuck Change

Quick Chuck Change (Manual)

Tool Changer

Automated Chuck Exchange System

Grip

Mini Cylinder

Accessories for Mini Cylinder

Container Cylinders

Accessories for Container Cylinder

Grippers

Buffer Material

Suction

Suction Cups

Suction Stem

Pad in Pad

Air Ejector/Filter/Check Valve

Micro Mold E.O.A.T

Cut

Mini Air Nippers

Air Nippers

Frame/Module

Jungle Gym

Let's Joint

Rectangular Tube

Base Aluminum Material

Sliding Chuck

Tubing/Sensors

Tubing

Sensors

Other Products

Others

Information



Sliding Chuck

- ▶ Suction stem can be moved freely according to the shape of workpiece.
- ▶ Chuck mounting section can be attached to other enterprises' robots.
The material of vertical bar was changed to duralumin to enhance rigidity.

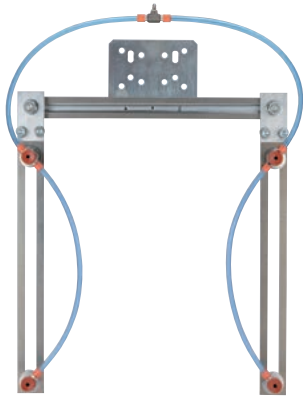

▶ Suction stem: for small
Sliding chuck (gate type)

| | |
|----------------|------------------|
| Order code No. | 054285 |
| Standard | FCK1-0000 |

- Weight : 1,160g
- Order the product separately except for a standard.

Development

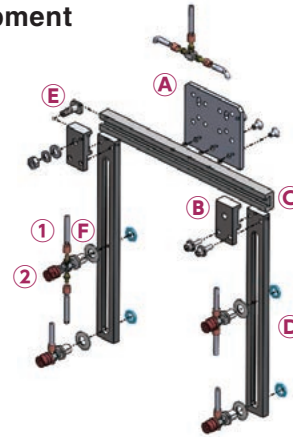

A Chuck mounting base

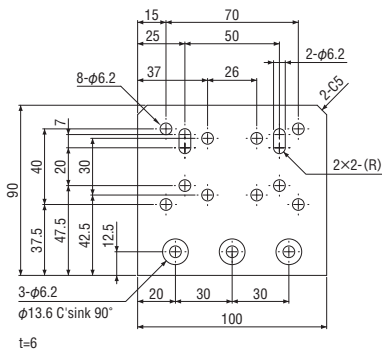

B Sliding holder

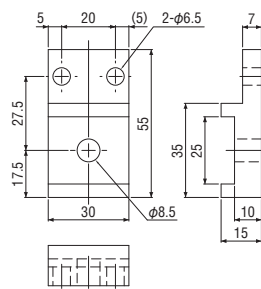

C Sliding chuck slide base

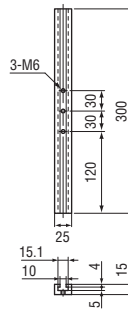
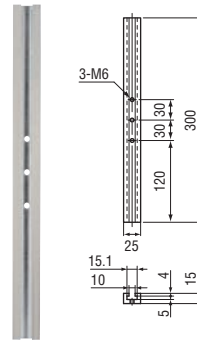

D Vertical bar (L)

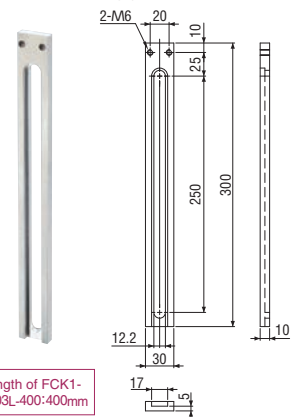

Length of FCK1-0003L-400:400mm

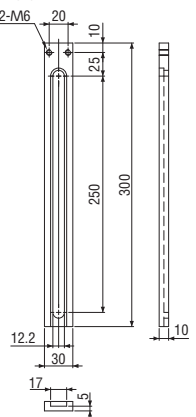

E Sliding chuck fastening bolt

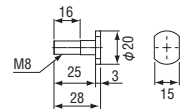

F Taper washer * for small

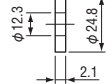

Specification

| | Product name | Standard | Order code No. | Weight (g) | |
|----------|--------------------------------------|------------------|----------------|---------------|-----|
| A | Chuck mounting base | FCK1-0001 | 054287 | 393 | |
| B | Sliding holder | FCK1-0002S | 054288 | 41 | |
| C | Sliding chuck slide base | FCK2-0004 | 054325 | 209 | |
| D | Vertical bar (L) | 300mm (standard) | FCK1-0003L | 054289 | 139 |
| | | 400mm | FCK1-0003L-400 | 054290 | 183 |
| E | Sliding chuck fastening bolt | FCK1-0005 | 054326 | 11 | |
| 1 | Suction stem for small (M5) | VFIL-S-5A | 210974 | 20 | |
| 2 | Suction cup (standard/silicon/brown) | VAPH-15C | 210193 | 2.2 | |
| F | Taper washer * for small | φ12 (for VFIL-S) | 370244 | 1 | |

Information of used bolt

| | Product name | Standard | Order code No. | Qty |
|------------|--------------------------------------|----------|----------------|-----|
| A+C | Flat head screw with hexagon socket | M6*10 | 122786 | 3 |
| | Nut class 1 | M8 | 122783 | 2 |
| B+C | Spring washer | M8 | 122776 | 2 |
| | Flat washer | M8 | 122781 | 2 |
| B+D | Bolt with hexagon socket (SW+flat W) | M6*20 | 122822 | 4 |

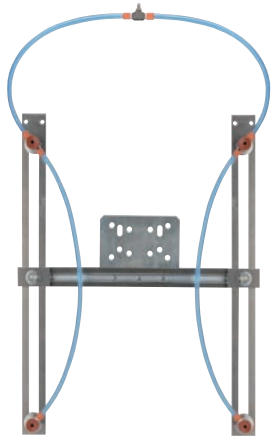

Development

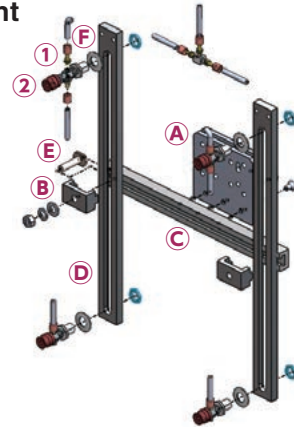

► Suction stem : for small
Sliding chuck (H type)

Order code No. **054286**
Standard **FCKH-0000**

- Weight : 1,160g
- Order the product separately except for a standard.

A Chuck mounting base

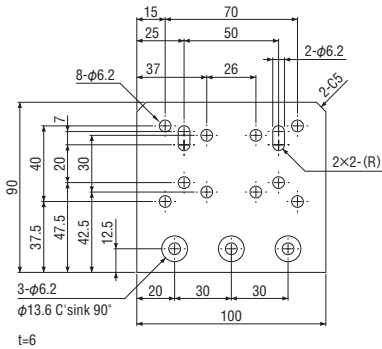

B Sliding holder H

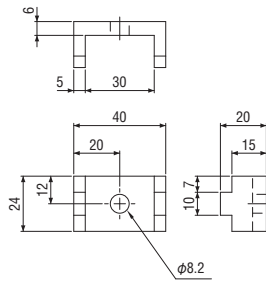

C Sliding chuck slide base

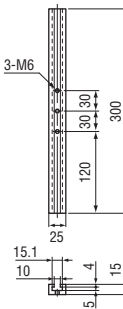
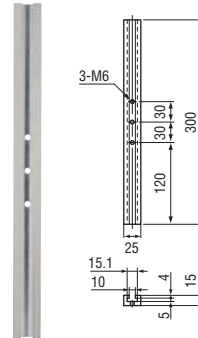

D Vertical bar (L)

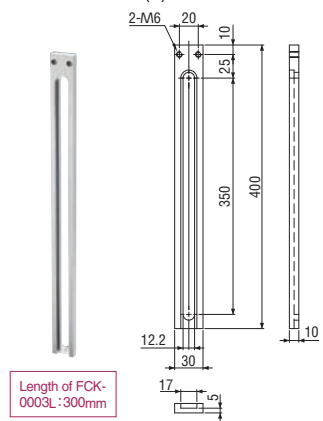
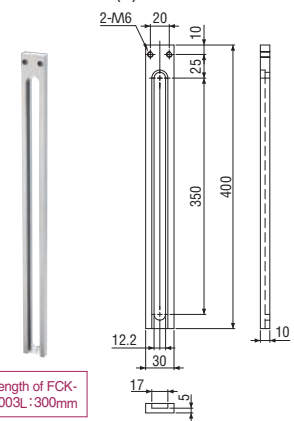

E Sliding chuck fastening bolt H

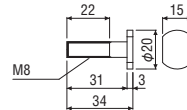
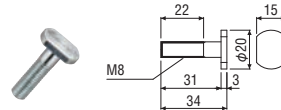

F Taper washer * for small

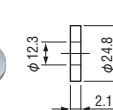
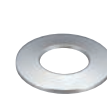

■ Specification

| | Product name | Standard | Order code No. | Weight (g) | |
|----------|------------------------------------------|------------------|----------------|---------------|-----|
| A | Chuck mounting base | FCK1-0001 | 054287 | 393 | |
| B | Sliding holder H | FCKH-0007 | 054291 | 21 | |
| C | Sliding chuck slide base | FCK2-0004 | 054325 | 209 | |
| D | Vertical bar (L) | 400mm (standard) | FCK1-0003L-400 | 054290 | 183 |
| | | 300mm | FCK1-0003L | 054289 | 139 |
| E | Sliding chuck fastening bolt H | FCKH-0005L | 054292 | 16 | |
| 1 | Suction stem for small (M5) | VFIL-S-5A | 210974 | 20 | |
| 2 | Suction cup (standard / silicon / brown) | VAPH-15C | 210193 | 2.2 | |
| F | Taper washer * for small | φ12 (for VFIL-S) | 370244 | 1 | |

■ Information of used bolt

| | Product name | Standard | Order code No. | Qty |
|------------|-------------------------------------|----------------|----------------|-----|
| A+C | Flat head screw with hexagon socket | M6 * 10 | 122786 | 3 |
| | | | 122783 | 2 |
| B+C | Spring washer | M8 | 122776 | 2 |
| | Flat washer | | 122781 | 2 |

Quick Chuck Change

Quick Chuck Change (Manual)

Tool Changer

Automated Chuck Exchange System

Grip

Mini Cylinder

Accessories for Mini Cylinder

Container Cylinders

Accessories for Container Cylinder

Grippers

Buffer Material

Suction

Suction Cups

Suction Stem

Pad in Pad

Air Ejector / Filter / Check Valve

Micro Mold E.O.A.T

Cut

Mini Air Nippers

Air Nippers

Frame/Module

Jungle Gym

Let's Joint

Rectangular Tube

Base Aluminum Material

Sliding Chuck

Tubing/Sensors

Tubing

Sensors

Other Products

Others

Information

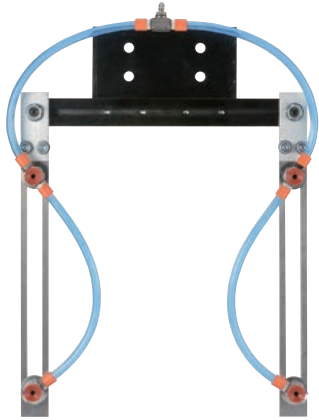

► Suction stem : for mini
Sliding chuck (mini)

| | |
|-----------------|------------------|
| Order code No. | 054324 |
| Standard | FCK1-1000 |
| ● Weight : 616g | |

Development

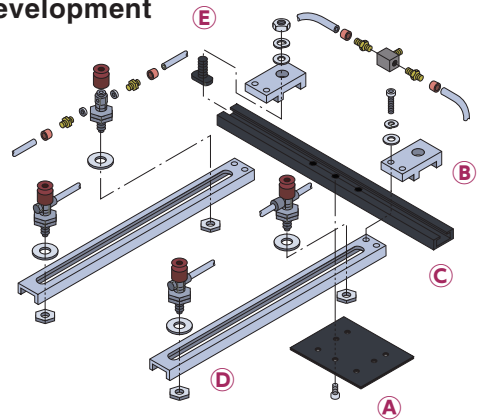

A Chuck mounting base

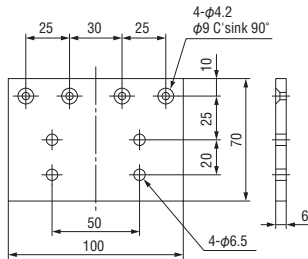

C Sliding chuck slide base

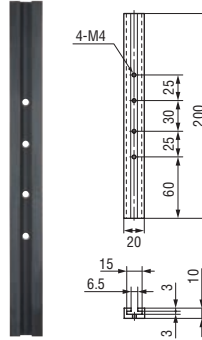

D Vertical bar

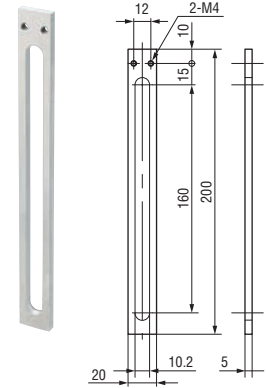

B Sliding holder

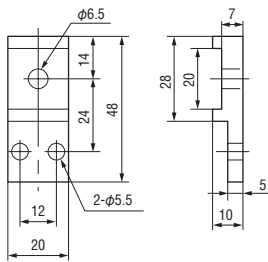

Sliding holder

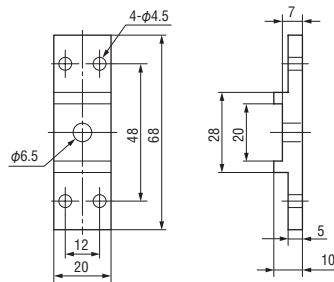

E Sliding chuck fastening bolt

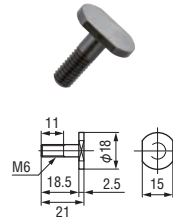

* Used to change to H type.

■ Specification

| | Product name | Standard | Order code No. | Weight (g) |
|----------|------------------------------|------------------|----------------|------------|
| A | Chuck mounting base | FCK-1001 | 370732 | 312.5 |
| B | Sliding holder | FCK1-1002 | 054321 | 16 |
| C | Sliding chuck slide base | FCK-1004 | 370735 | 69 |
| D | Vertical bar 200mm | FCK1-1003 | 054322 | 32 |
| E | Sliding chuck fastening bolt | FCK-1005 | 370736 | 7.5 |
| | Sliding holder | FCK-1006 | 050794 | 21 |

* Used to change to H type.

■ Information of used bolt

| | Product name | Standard | Order code No. | Qty |
|------------|--------------------------------------|--------------|----------------|-----|
| A+C | Flat head screw with hexagon socket | M4*8 | 122785 | 4 |
| B+C | Nut class 1 | M6 | 122782 | 2 |
| | Spring washer | M6 | 122775 | 2 |
| | Flat washer | M6 | 122780 | 2 |
| B+D | Bolt with hexagon socket (SW+flat W) | M4*12 | 122812 | 4 |